

Tecalemit flexibles™



Tenir au Temps

PNEUMATIC TUBES





Tecalemit flexibles™



Tenir au Temps

TECALEMIT FLEXIBLES® with its strong brand name and patents, driven and supported by professionals, is your security-guaranteed supplier of flexible pipes and tubes, hoses and fittings provided by three departments.

Tecalemit RCMH™



Rubber hoses, PVC hoses,
protection sheaths, fittings RCMH
TECALEMIT®

flexibles Tecalemit™



Hydraulic hoses, protection sheaths,
systeme of flexibles reassured
Protocalan

tubes Tecalemit™



Technical tubes, spiralled tubes,
multitubes, connectors &
accessories tubes





Historic TECALEMIT FLEXIBLES®



E.Piquerez



J.Christe

Emile Piquerez had invented his famous forced lubrication with a simply attached coupler clip and given it the name "THÉCLA".

As for Joseph Christe, he had struck an agreement in the United States with the company "ALEMITE" through which the Piquerez patents were sold to this company for America in exchange for its own lubrication patents with bayonet connector for Europe.

This was the starting point of the company TECALEMIT, its offices, shops, workshops and service stations were set up by its two founders 18 Rue de Brunel in Paris in May 1922.

The name "TECALEMIT", a combination of "THÉCLA" and "ALEMITE", was to remind users of forced lubrication that they would find here devices by both brands.

Car owners came in their droves to get their lubricators replaced in only 15 or 20 minutes for just 100 Francs, which at the time was about £5 or \$20.

But TECALEMIT did not rest on its laurels. From the lubrication pump with a flexible hose and coupler clip, they moved on to the pushing pump with rigid hose and articulated clip, then onto LUB and ZERK lubrication, and finally to an even more perfected system that is still used today in almost all cars and machines built anywhere in the world: the "Hydraulic" system.

1946 saw the first "TELECAMIT" rubber hoses with crimped connections, then the flexible pipework "TECALEMIT- AEROQUIP" with dismantlable connections were released in 1950, followed by flexible polyamide 11 pipes or flexible polyurethane 12 pipes that were manufactured in the Orly plant under the brand name Tecalan® from 1961.

In 1972, a factory fully dedicated to these products was built in Blois, where TECALEMIT FLEXIBLES® (brand registered in 1980) had its head office Avenue de Châteaudun.

In January 2006, all activities, except those dedicated to aerospace, were transferred to Pont l'Abbé, Route de Combrit, in Brittany.

Tecalemit Flexibles, ISO 9001 certified and with its approved economic operator status, offers a complete range of pipework and hoses with dismantlable or crimped connections for remote hydraulic controls in addition to all the pneumatic tubes manufactured in Pont l'Abbé under the brands MANURIL®, MANULAN® and MALUFORM®. All these devices were primarily designed for the automotive market but have also conquered aviation, railways, the marine, civil engineering and the industry as a whole.



Y. Tromelin , the President of TECALEMIT FLEXIBLES®

The sister companies RCMH-Tecalemit and Tecamec are located only 800m away from the complete technical and sales offer.

RCMH-Tecalemit designs and manufactures flexible elastomer hoses used to transfer fluids in industry. The company has approved economic operator status and is ISO 9001 certified and also benefits from authorisations from DREAL (French Environment, Development, and Housing Directorate) via its AFNOR certification to manufacture hoses for dangerous substances for clients in civil defence.

Tecamec manufactures connectors, hose caps and standoffs, as well as flexible hoses in stainless steel. These products are aimed at civil defence, welding, and energy industry (oil & gas, nuclear, off-shore rigs, FPSO LNG), civil engineering, sewers, and the steel industry.

Yann Tromelin, président de TECALEMIT FLEXIBLES®

Aerial view of the town of Pont l'Abbé



Photo Credit Claude BUHANNIC





INDEX

	Standard	Characteristics	Page
TECHNICAL GUIDE			
		Technical generalities of mono-component tubes	8
		Definition of physical properties	9
		Mechanical properties	9
		Thermal properties	10
		Flammability properties	10
		Optical properties	11
		Comparison table of characteristics of different materials	11
		Chemical compatibility chart	12
PNEUMATIC TUBES			
	DIN 73378	MANURIL® polyamide PA 12 PHL Rilsan A	22
	DIN 73378	MANURIL® polyamide rigid PA 12 HL Rilsan A	24
	DIN 74324	MANURIL® polyamide PA 12 PHL ABR Rilsan A	25
	DIN 73378	MANURIL® polyamide PA 11 PHL Rilsan B	26
	DIN 73378	MANURIL® polyamide PA 11 HL FDA Rilsan B	27
	NFE 49101	MANULAN® polyurethane	28
		MANULENE® low density polyethylene	30
		MANULEF® PVDF	31
	TECAFLON® PTFE	32	
MONOTUBES & MULTITUBES			
		Coextruded TAT	34
		Monotube polyamide with PVC sheathing	35
		Multitube polyamide with PVC sheathing	36
PREFORMED TUBES MANURIL® ET MANULAN®			
		Thermoformed tubes on plan	38
		Industrial spirals	39
TUBE ACCESSORIES & PACKAGING			
		Reinforcing sleeve & tube cutter	40
		PA/PU tube packaging	41



INDEX

Standard	Characteristics	Page
COMPOSITE HOSES MANUCLAIR®, MANUFLEX®, MALUFORM®		
	MANUCLAIR® translucid tube	42
	MALUFORM® hose	43
	MANUFLEX® hose	44
PNEUMATIC CONNECTORS		
	Tool-less modular rectangular connector	45
	Bulkhead connector	46
	Tool-less push-in round connector	48
	Modular rectangular electropneumatic connector	50

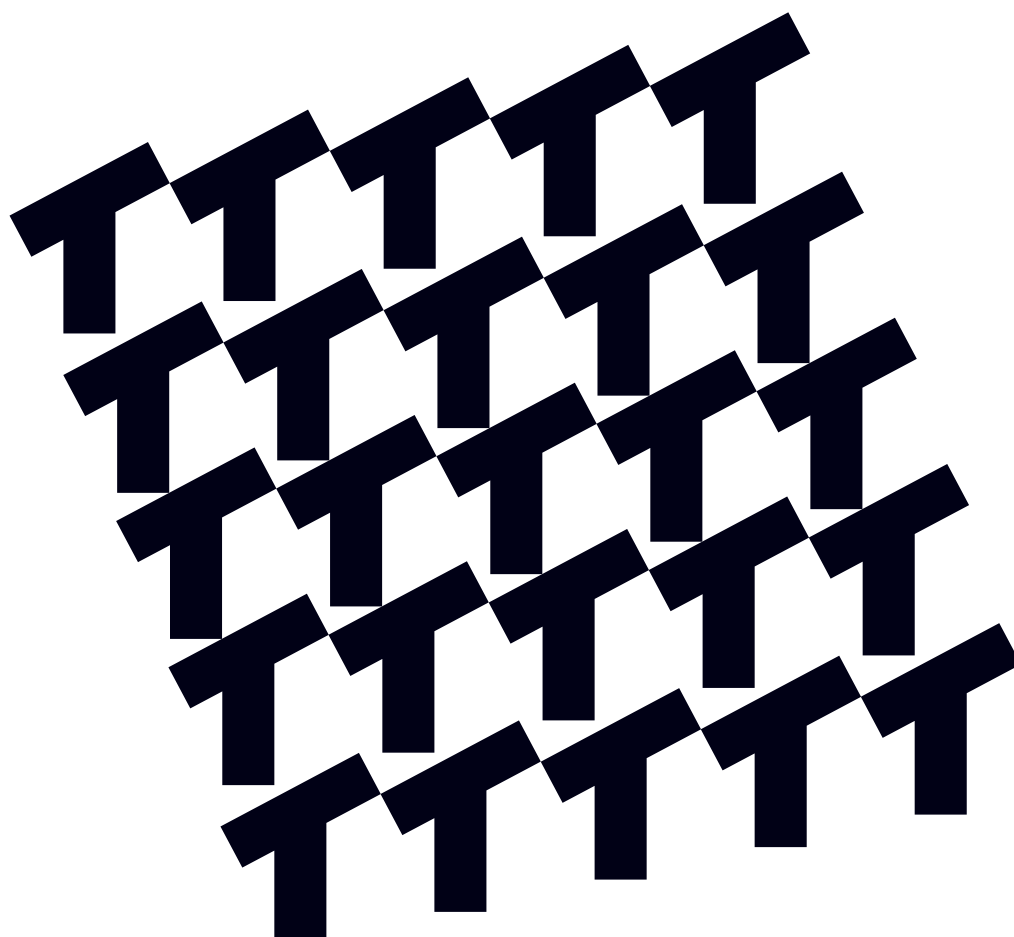

TECHNICAL GUIDE TECALEMIT FLEXIBLES®

TECALEMIT FLEXIBLES® tubes :

The range of TECALEMIT FLEXIBLES® technical tubes are divided into 8 families. First the monocomponent tubes :

- MANURIL® polyamide tubes
- MANULAN® polyurethane tubes
- PTFE TECAFLON® PTFE tubes
- PVDF MANULEF® PVDF tubes
- MANULENE® low-density polyethylene tubes

The range is enriched by the following tubes of composite structure :

- MANUCLAIR® PVC tubes (pvc tube/textile braid/pvc cover)
- MANUFLEX® tubes (nitrile rubber tube/galvanised steel braid/pvc cover) - MALUFORM® (aluminium tube/polyethylene cover)

Production of tubes :

Mono-component tubes are produced by extrusion, whose parameters vary according to material and diameters, but which practically all have the following stages, with the exception of ptfе which is produced by vertical ram extrusion.

First the granules of these thermoplastic materials are brought to their melting temperature, homogenised and compressed by the helical screw of the extruder.

Passing through the extrusion head, the liquid plastic material is projected towards a cooled calibrated die, under vacuum, accompanied by a film of water. The tube is then cooled, and its wall thickness controlled by ultra-sound and its outer diameter controlled by infra-red.

These control figures are used to fine-tune the parameters of the extruder with regards to outer diameter and wall thickness. The surface of the tube is then passed through a flame before being ink marked by thermo-diffusion, before arriving at the final traction devices for winding on reels.

1 Technical generalities of mono-component tubes

Institutes of standards define a certain number of characteristics of polyamide and polyurethane tubes in general use or used for vehicle brake systems. They particularly cover inner and outer dimensions and thicknesses that can be found in the technical characteristics table of MANURIL® and MANULAN® tubes. They also cover working and burst pressures which are also indicated. These standards also define a certain number of tests which characterise the aptitude of the tube's use.

For instance :

- Tests on the absorption of moisture checks dimensional stability in humid atmospheres
- Testing the resistance to zinc chlorate checks the aptitude of the tube when used in contact with metallic parts (fittings)
- Aging tests
- Cold flexibility tests
- Cold impact tests which, combined the previous test defines the minimum temperature for use.

Other tests can be defined which concern the quality of the the material and these tests can be found in the preceding paragraph.

One of these tests concerns the load tension :

The burst pressure of a tube is directly issued from the load on the material at a test temperature, according to following formula :

$$BP = LT \times 20 \times TH / (OD - TH)$$

Where for a test temperature :

BP = Burst pressure in bars

LT = Load tension in n/mm²

TH = Thickness of tube in mm

OD = Outer diameter of tube in mm

Hereafter follows some values of the load tension at 23°C :

- Plastified polyamide (MANURIL® semi-rigid tube) : LT = 20 n/mm²
- Rigid polyamide (MANURIL® rigid tube) : LT = 40 n/mm²
- Polyurethane (MANULAN® tube) : LT = 9 n/mm²
- Polyethylene (MANULENE® tube) : LT = 8 n/mm²

TECHNICAL GUIDE TECALEMIT FLEXIBLES®

2 Définition des Propriétés Physiques

2 1 Definition of physical properties

The volumic mass is the mass by volume unit of a material at a given temperature (°C). It is expressed in Kg/m³ (or g/cm³). Please note that volumic mass indicated in the comparison table of different materials is, of course, in their solid state as determined by NF T 51-063.

2 2 Absorption of water and moisture

Absorption of water plays an important role with regards to electric properties, mechanical properties (for example, polyamides are plastified by water) and for long term properties for materials subject to hydraulic degradation.

The action of water can also give way to modifications in dimensions.

The following table gives water absorption values according to NF T 51-166 and moisture absorption values according to NF T 51-290.

3 Mechanical properties

3 1 Definition of elasticity modulus

The elasticity modulus (or tensile modulus) is defined as the slope creating the tangent of the stress-strain curve in low deformations

Physically, this characteristic expresses the stiffness of the material (the higher the value, more the tube is rigid).

It is expressed in megapascals (Mpa) and obtained by tensile tests according to NF T 51-034

3 2 Definition of yield stress

Yield stress is usually employed as the the yield point. It is defined as the force applied to the yield stress point by the initial section of the sample on which a tensile load is applied according to NF T 51-034 and expressed in megapascals (Mpa).

3 3 Definition of breaking stress

Breaking stress is defined as the quotient of the applied force at the time when the sample breaks by its initial section.

It is obtained by tensile tests according to NF T 51-034 and expressed in megapascals (Mpa).

3 4 Definition of elasticity in flexion

The elasticity modulus in flexion or flexion modulus or resistance to flexion qualifies the material's resistance to deformation.

This value is determined by a flexion test according to NF T 51-104 and expressed in megapascals (Mpa).

3 5 Definition of creeping modulus

Creeping is defined as a slow deformation of a solid subjected to sufficiently prolonged efforts.

Under this constant force, the solid is subjected to a primary deformation during application of the effort and it is only from this point that any deformation is due to creeping.

It is expressed in megapascals and determined by NF T 51-103 and given for 1 hour and 1000 hours.

3 6 Impact behaviour

The values obtained during tests allow an estimation, in experimental conditions, of the fragility of a material.

The table gives results according to the Charpy test (widely used in Europe and given according to NF T 51-035) and the IZOD test (used in the United States and given according to NF T 51-035) and for notched and un-notched samples.

3 7 Definition of hardness

The shore hardness given in the table is according to NF T 51-109 and obtained by using simple conical indenters with direct reading from 0 to 100 ('0' corresponds to full penetration, '100' corresponding to maximum hardness, that is no penetration of the indenter into the material).

Two scales of hardness are used : shore A for soft materials and shore D for harder ones.

The difference in readings comes simply from the shape of the indenter.

TECHNICAL GUIDE TECALEMIT FLEXIBLES®

3 8 Definition of resistance to friction

Wear is a loss of material from the surface of a body subjected to a mechanical action and is always due to the contact of the material with a foreign body.

In the case of tubes, it can be the rubbing against a solid body, contact with an abrasive element or contact with a point, creating a scratch.

Wear is measured in mm² (of surface worn during test) or in mm³ (volume of material recuperated following friction test) as well as the tangential force resulting from friction and the normal force applied on the sled used for testing.

4 Thermal properties

4 1 Definition of melting and crystallisation temperatures

Melting temperature is the moment when the material passes from a crystallised state to a liquid state.

Crystallisation temperature is when the material passes from a liquid state to a crystallised state.

Many methods (often visual) are used to obtain these values according to the material : these have been used to complete the following table.

The melting temperature of plastics only has meaning if the material has a definite melting point at a determined temperature. In the other case, it is preferable to consider the Vicat softening temperature described hereafter.

4 2 Definition of temperature of deflection under load

Temperatures of deflection under different load values characterise the behaviour of rigid plastics under load at high temperatures.

This value is particularly important in the case of tubes as it indicates the reduction of supported pressures under the effect of a hot liquid.

They are given in degrees celsius according to NF T 51-005 which describes, for example, the increase rate of temperature : This way, normalised values can be distanced from the real use of the tube and it is for this reason that individual tube data sheets give the reductions in working pressures according to working temperature.

4 3 Definition of Vicat softening temperature

The temperature at which a flat-ended rod of 1mm² penetrates a sample is considered the Vicat softening temperature. It largely replaces the melting temperature in the case where the material does not have a definite melting point at a determined temperature.

This value is given in degrees celsius according to normalised test NF T 51-021.

4 4 Definition of temperature of cold brittleness

It is a conventional temperature at which flexible plastic materials at ambient temperature, present brittle fracture according to the mechanical tests described above in the impact behaviour of materials (Charpy or Izod tests).

They can also be determined by a torsion test according to NF T 51-104.

It can be used for specifications or to compare different tubes, but does not necessarily determine the lowest temperature at which the tube can be used.

4 5 Definition of thermal conductivity

Conductivity quantifies the capacity of a material to conduct heat. The indicated values correspond to the normalised test NF X 10-021 and are expressed in watts per metre and per degree kelvin (W.m⁻¹.K⁻¹).

5 Flammability properties

5 1 Definition of UL94 flammability

The widely used UL94 flammability test has, for object, to indicate the capacity of a material to allow a flame to extinguish itself, once lit.

The best classification is VO followed, in order, by V1, V2z and lastly HB. It is important to note that UL 94 classification must always indicate the thickness of the sample used.

Whereby, the same material can be classed VO in 1.6mm thickness and V1 in 3.2mm thickness.

Certain materials are naturally fire-resistant (for example PTFE), for the other polymers, it is possible to increase their flame resistance with fire-resistant additives.

TECHNICAL GUIDE TECALEMIT FLEXIBLES®

5 2 Definition of oxygen rating

The oxygen rating according to NF T 51-071 gives an idea of the material's behaviour under combustion by indicating the minimum percentage of oxygen in an oxygen-nitrogen mixture which maintains the material in combustion. The higher this value, the better the behaviour of the material under flame.

6 Optical properties

6 1 Definition of transparency

Transparency is the aptitude of a body to transmit a ray of light without diffusion. It is expressed in percentage according to NF T 51-068 or according to approximative criteria.

7 Comparison table of characteristics of different materials

FAMILY	POLYAMIDE			POLYURETHANE		FLUORINATED POLYMERS		POLYETHYLENE	VINYL	ELASTOMERES
	MATERIAL	PA11PHL	PA12PHL	PA12 HL	Polyether Base	Base Polyester	PTFE	PVDF	PEBD	Flexible PVC
PHYSICAL PROPERTIES										
Volumic mass (g/cm ³)	1.05	1.03	1.02	1.15	1.21	2.17	1.78	0.91	1.38	0.95
Water absorption (%)	1.5	1.4	1.6	1.5		0.01	0.03	0.03		0.01
Moisture absorption (%)	0.7	0.6	0.7			0.01	0.015			0.01
Crystallinity (%)	25.0	25.0				85	50.0	65	0.0	72.0
MECHANICAL PROPERTIES										
Elasticity modulus (mpa)		430	1440	70	160	350	1700	300	1500	500
Yield strength (Mpa)	27	24	41	11	8	30	50	13	15	24
Elongation at yield (%)	32	25	8	50	50		7			
Breaking strength (Mpa)	48	50	53	56	60	25	48	18	17	25
Elongation at break (%)	300	290	310	490	480	250	51			
Elasticity modulus in flexion (mpa)	350	400	1200	500	550		2000	200	1500	1150
Creep modulus in traction 1 hour (Mpa)		800				750	1050			
Creep modulus in traction 1000 hours (Mpa)		450					570			
Charpy notch test (KJ/m ²)	16	99	8.5	20			14			4
Izod notch test (KJ/m ²)	20	12				NB				
Izod un-notch test (KJ/m ²)	7.4	4				16	10			3.0
Hardness shore A	99	99		96					70	65
Hardness shore D	62	60	70	48	50	58	77	43		
Resistance to abrasion				40	42	Poor				
THERMAL PROPERTIES										
Melting temperature (°C)	182	174	178			327	170	11	80	135
Temp. of deflection under load 1.8 mpa (°C)	45	46	55	62	105	55	105	30		50
Temp. of deflection under load 0.45 mpa (°C)	130	125	135	100		135	135	40		85
Vicat b softening temperature (°C)	160	145	145	75	90	110	140	80		
Cold fragility temperature (°C)				-50	-40	-175	-40	-80	-20	-80
Thermal conductivity (wm-1k-1)	0.29	0.32	0.32	0.22	0.25	0.24	0.18	0.30	0.17	0.40
FLAME PROPERTIES										
Flammability of a 1.6mm thick tube	HB	HB	HB	HB à V2		VO	VO	HB	HB	HB
Oxygen index (%)	25					95	44	17	30	17
ELECTRICAL PROPERTIES										
Dielectric constant 100khz		3.7	3.7	4.5		2	11		4	2.4
Dielectric constant 1mhz	3.7	2.2	2.2	4.2		2	8	2.3		2.4
Dissipation factor 100mhz				0.018		0.00003	0.025	0.0003	0.1	0.0003
Dissipation factor 1mhz	0.05	0.03	0.03	0.01		0.0005	0.23	0.0002		0.0004
Transverse resistivity (ohm)	7.8E+13	1.0E+15	1.0E+15	7.0E+14		10E+17	2.0E+14	1.0E+17	1.0E+13	1.0E+17
Superficial resistivity (ohm)	1.0E+14	1.0E+14	1.0E+14	1.0E+14		1.0E+15	1.0E+15	1.0E+15		1.5E+13
Dielectric rigidity (kv/mm)	23	24	32	25			27	40	20	17 à 120
Comparative tracking index				600		600	600	140		600
Arc resistance (dry)						200	60			
OPTICAL PROPERTIES										
Transparency	Poor	Bad	Bad	Good	Good	Bad	93%	Good	Good	Bad

CHEMICAL COMPATIBILITY CHART

This guide has been designed to assist in the optimal choice of the material comprising TECALEMIT FLEXIBLES® technical tubes, according to conveyed or surrounding fluids. The following information results from static tests on solid samples immersed in chemical reactives (or their dilutions)

Not taken into account :

- Dynamic reaction, particularly cracking under strain
- Synergy effects when several fluids are in contact

Miscellaneous external aggressions should also be taken into account : Weather - ultraviolet - temperature - pressure, etc... to which tubes can be subjected.

The chemical products listed are the most frequently encountered ones. Please contact the technical department for any particular assistance.

Abbreviations

TEMP °C : Temperature expressed in degrees CELSIUS

P.A : Polyamide 12 - MANURIL®

P.U : Polyurethane - MANULAN®

P.E : Polyethylene - MANULÈNE®

P.V.D.F : Polyvinylidene fluoride - MANULEF®

F.E.P : Fluorinated ethylene propylene

P.F.A : Perfluoralkoxy

P.T.F.E : Polytetrafluoroethylene

P.V.C : Polyvinyl chloride

N.B.R : Nitrile butadiene rubber

1 : Little or no effect

2 : Minor effect

3 : Moderate effect

4 : Severe effect

CHEMICAL PRODUCT	CONCENTRATION	TEMP °C	PA	PU	PE	PVDF	FEP	PFA	PTFE	PVC	NBR
Acetic acid	10 % aqueous solution	20	1		1	1	1	1	1	1	4
		60	4		1	1	1	1	1	1	4
	50 % aqueous solution	20	4		1	3	1	1	1	1	4
		60	4		4	3	1	1	1	1	4
Acetic acid glacial	100 %	20	4		1	3	1	1	1	1	
		60	4		4	3	1	1	1	4	
		80	4		4	4	1	1	1	4	
Acetic aldehyde	100 %	20	1		1	4	1	1			
		60	3		3	4	1	1			
Acetic anhydride	100 %	20	3	4	4	4	1	1	1	4	2
		60	4	4	4		1	1	1	4	2
Acetone	100 %	20	1		1	4	1	1	1	4	4
		60	3		4	4	1	1	1		4
Acetylene	100 %	20					1	1	1	1	1
		60					1	1	1	1	1
Acrylonitrile	100 %	20		4	1	3	1	1			
		40		4	1	4	1	1			
		60			1	C	1	1			
Actic acid	10 % aqueous solution	20	3	4	1	1	1	1	1	1	1
		60	4	4	3	3	1	1	1	1	1
Adipic acid	Saturated aqueous solutions	20		3	1	1	1	1	1	1	
		60		4	1	1	1	1	1	1	
Aqua regia		20	4	4	4	1			1	1	4
Aluminium chloride	Saturated aqueous solution	20	1	1	1	1			1	1	
		60	3	3	3	1			1	1	
Ammoniac	Cold saturated aqueous solution	20		3	1	3	1	1	1	3	2
		60		4	4	4	1	1	1	4	2
Ammoniac (gas)	100 %	20	1		1	1	1	1		1	2
		40	1		1	1	1	1		1	2
		60			3	3	1	1			1
Ammonium carbonate	50 % aqueous solution	20			1	1			1	1	4
		60			4	1			1	1	4
Calcium bisulfite	Cold saturated aqueous solution	20				1	1	1		1	
		80				1	1	1		1	
Calcium chloride	All aqueous solution concentrations	20	3		1	1			1	1	
		60	4		4	1			1	1	

CHEMICAL COMPATIBILITY CHART

1 : Little or no effect 2 : Minor effect 3 : Moderate effect 4 : Severe effect

CHEMICAL PRODUCT	CONCENTRATION	TEMP °C	PA	PU	PE	PVDF	FEP	PFA	PTFE	PVC	NBR
Calcium hydroxide	Cold saturated aqueous solution	20		4	1	1			1	1	2
		60		4	4	3			1	1	3
Carbon dioxide	100 % gas and dry	20	1	1	3	1					1
		60	1	1	4	1					1
carbon disulfide	100% pure chemistry	20	1	4	3	1			1	3	
carbon tetrachloride	100 %	20	1		3				1		
		60							1		
		80							1		
Chloric acid	20 % aqueous solution	20	4	4	3	1	1	1		1	4
		60	4	4			1	1			1
Chloride of lime	Cold saturated aqueous solution	20	4		1	1					
		60			1	3					
Chloride ammonium	Cold saturated aqueous solution	20	1	1	1	1			1	1	
		60	3	3	3				1	1	
Chlorine	100 % Gaseous and dry Gaseous and wet	20	4	4	3	1					3
		60	4	4	4	1 1					3
		20									
Chlorine	100 % Liquid and dry Saturated aqueous solution	20	4	4	4	4			1		3
		60	4	4	3	1			1		3
		20									
Chloroacetic acid	50 % aqueous solution	20	4		1	1	1	1	1	1	
		60			3	4	1	1	1	3	
Chlorobenzene	100 %	20	4	4	3	1			1	4	
		60				3			1	4	
Chloroform	100 %	20	3	4	4	1			1	4	4
		60	4			1			1	4	4
Chlorosulphonic acid	100 %	20		4	4	3	1	1	1	1	
		60		4	4	4	1	1	1	4	
Chromic acid	50 % aqueous solution	20	4	4	3	1	1	1	1	1	4
		60			4	3	1	1	1	1	4
Citric acid	10 % aqueous solution	20	1	1	1	1	1	1	1		2
		60	3	4	3	1	1	1	1		2
Coconut oil	100 %	20	1	1	1	1					1
		60	1	3	3	1					1
Copper chloride	All aqueous solutions	20			1	1			1	1	
		60			1	1			1	1	
Creosote	Cold saturated aqueous solution	20	4	4	3	1			1	1	2
		60		4		3			1	4	2
		80		4		4			1		2
Cyclohexanol	100 %	20	1	4	1	1			1	4	
		60		4	3	3			1	4	
Cyclohexanone	100 %	20	1	4	3	1			1	4	
		60	4	4	3	3			1	4	
Cyclohexane	100 %	20	1	1	1	1			1	4	
		60	3	3	3	1			1	4	
dibutyl phtalate	100 %	20	1		3	3			1	4	4
		60	1		4	4			1	4	4
Dichloroacetic acid	100 %	20			1	1	1	1	1		
		60			3	3	1	1	1		
Dichlorobenzene	100 %	20		4	3	1			1		
		60		4		1			1		
		80		4		3			1		
Dichloroethylene	100 %	40		4	4	1				4	
Dibutyl ether	100 %	20			3	4					
		60			4						

CHEMICAL COMPATIBILITY CHART

1 : Little or no effect

2 : Minor effect

3 : Moderate effect

4 : Severe effect

CHEMICAL PRODUCT	CONCENTRATION	TEMP °C	PA	PU	PE	PVDF	FEP	PFA	PTFE	PVC	NBR
Diethylamine	100 %	20		4		1			1	4	
		40		4		3			1	4	
		60		4		4			1	4	
Dimethylamine	100 %	20		4	1	4			1	4	4
		60		4	3	4			1	4	4
Dimethylformamide	100 %	20		3	4	1	4		1		
		60		4	4	3			1		
Diocetyl phthalate	100 %	20	1		3				1		
		60	1						1		
Dioxane	100 %	20	1	1	1	3			1		4
		60			3	1	4		1		4
		80			4	1			1		4
Disobutyle ketone	100 %	20		4	1	1			1		
		60		4	4	3			1		
Ethane	100 %	20	1	1		1		1			1
Ethanol	100 %	20	3		1	1			1		1
		60	4		1	1			1		1
Ethyl acetate	100 %	20	1		3	3	1	1	1	4	4
		60	1		4	4	1	1	1		4
Ethyl alcohol	All aqueous solution concentrations	20	3	3	1		1	1	1	1	
		60	4	3	1		1	1	1	1	
Ethyl chloride	100 %	20	1	4	3	1			1	4	2
		60	4						1	4	2
Ethyl ether	100 %	20		4	3	1			1	4	
		60							1	4	
Ethylene chloride	100 %	20	3		3	1			1	4	4
		60	4						1	4	4
Ethylene glycol	100 %	20	1	1	1	1			1	1	1
		60	3		3	1			1	1	1
ethylene oxide	100 %	20			4	1			1		4
		60				1			1		4
		80				3			1		4
Ethylenediamine	100 %	20		4	1	4			1		2
		60		4	1	4			1		2
Fluorine (gas)	100 % sec	20	4	4	4	4			1		
Fluorhydric acid	40 % aqueous solution	20	4	4	1	1	1	1	1	1	3
		60			3	1	1	1	1	1	3
Formaldehyde	40 % aqueous solution	20	3	4	1	1			1	1	1
		60	4	4	4	4			1	1	1
Formic acid	50 % aqueous solution	20	4	4	1		1	1	1	1	3
		60			3	4	1	1	1	4	3
Freon 11	100 %	20							1		
		60							1		
Freon 12	100 %	20	1						1	1	
		60									
Freon 21	100 %	20									
		60									
Freon 22	100 %	20	1						1		
		60							1		
Freon 113	100 %	20	1			1			1		
		60							1		
Freon 114	100 %	20									
		60									
fuel-oil	100 %	20	1	1	3	1				1	1
		60			4	1				1	1

CHEMICAL COMPATIBILITY CHART

1 : Little or no effect 2 : Minor effect 3 : Moderate effect 4 : Severe effect

CHEMICAL PRODUCT	CONCENTRATION	TEMP °C	PA	PU	PE	PVDF	FEP	PFA	PTFE	PVC	NBR
Furfuryl alcohol	100 %	20			1	1	1	1			
		60			1	3	1	1			
Glucose	All aqueous solution concentrations	20	1	1	1	1			1	1	1
		60	1	3	3	1			1	1	1
Gycolic acid	37 % aqueous solution	20		1	1	1	1	1	1	1	1
		60		4	3	3	1	1	1	1	1
Heptane	100 %	20	1	1	1	1			1		
		60			3	1			1		
Hexane	100 %	20	1	1	1	1			1	1	1
		60			3	1			1		1
Hydrazine hydrate	Aqueous solution	20		1	1				1		4
		60		3	1				1		4
Hydrobromic acid	50 % aqueous solution	20			1	1	1	1	1	1	4
		60				1	1	1	1	1	4
Hydrochloric acid	37 % aqueous solution	20	4	4	1	1	1	1			3
		60			1	1	1	1			3
Hydrogen	100 %	20	1	1	1	1			1		1
		60			3	1					1
Hydrogen chloride	100 % gaseous and dry	20		4	1	1					
		60	3	4	1	1					
Hydrogen peroxide	10 % aqueous solution	20	1		1	1			1	1	1
		80	4		3	1			1	1	2
	30 % aqueous solution	20	4		1	1			1	1	1
		60			4	1			1	1	2
	90 % aqueous solution	20	4		3	1				1	1
		60									3
Isooctane	100 %	20	1		1	1			1		1
		60	1			1			1		1
Isopropanol	100 %	20	1	1	1	1					
		60	4	3	3	1					
		80		4		3					
Isopropyl ether	100 %	20		1	3				1		4
		60		1	4				1		4
Kerosene	100 %	20	1		1	1			1	1	
		60	3		3	1			1	1	
Lead acetate	Saturated solutions	20			1	1	1	1	1	1	4
		60			4	1	1	1	1	1	4
Lubricating oil	100 %	20		1	3	1			1	1	1
		60		3		1				1	1
Magnesium chloride	All aqueous solutions	20	1		1	1			1	1	
		60	1		3	1			1	1	
Maleic acid	Cold saturated aqueous solution	20		3	1	1	1	1	1	1	1
		60		4	3	1	1	1	1	1	1
methanol	All aqueous solution concentrations	20	1		1	1			1		1
		60	3		3	1			1		1
Methyl acetate	100 %	20				4	1	1	1	4	4
		60	1			4	1	1			4
methylamine	32 % aqueous solution	20		4	1	4			1		4
		60				4			1		4
Methyl bromide	100 %	20	1	4	3	1	1	1	1	4	
		60							1	4	
Methyl chloride		20	1		3	1			1	4	4
		60	3			1			1	4	4
		80							1	4	4
Methylene chloride	100 %	20	4		3	1			1	4	4
		60	4			4			1	4	4

CHEMICAL COMPATIBILITY CHART

1 : Little or no effect

2 : Minor effect

3 : Moderate effect

4 : Severe effect

CHEMICAL PRODUCT	CONCENTRATION	TEMP °C	PA	PU	PE	PVDF	FEP	PFA	PTFE	PVC	NBR
methylethylcetone	100 %	20	1	4	1	3			1	4	
		60	3	4	4	4			1	4	
mercury	100 %	20	1	1	1	1				1	1
		60	1	1	4	1				1	1
morpholine	100 %	20			1	1			1		
		60			1	3			1		
naphtalene	100 %	20	1		1	1				4	
		60	4		3	3				4	
Nitric acid	40 % aqueous solution	20	4	4	3	1	1	1	1	1	3
		60		4	4	1	1	1	1	3	3
	60 % aqueous solution	20	4	4	3	1	1	1		1	4
		60		4	4	1	1	1		3	4
Nitric acid	100 %	20	4	4			1	1		1	4
		60		4			1	1		4	4
		80					1	1		4	4
nitrobenzene	100 %	20		4	1	1			1	4	4
		60	4	4	4	4			1	4	4
Oil ASTM n°1	100 %	20	1	1	1	1					1
Oil ASTM n°2	100 %	60			3	1					1
Oleic acid	100 %	20	1	3	3	1	1	1	1	1	1
		60	3	4	4		1	1	1	1	1
oleum	H2SO4 + 10% SO3	20	4	4	4	4			1	4	
		60		4					1		
Oxalic acid	All cold saturated aqueous solution	20	1	3	1	1	1	1	1	1	3
		60	3	3	3		1	1	1	1	1
oxygen	100 % pure	20	1	1	1	1			1		4
		60			3	1			1		4
oxygen peroxide	10 % aqueous solution	20			1	1					
		60	4		3	1					
	30 % aqueous solution	20	4		1	1					
		60			4	1					
	90 % aqueous solution	20			3	1					
		60									
ozone	2% in air	20	1	4					1	1	4
		60							1	1	4
Paraffin oil	100 %	20	1	1	1	1			1	1	1
		60	1	3	1	1			1	1	1
Perchloric acid	10 % aqueous solution	20	3	4	1	1	1	1	1		
		60	4	4	1	1			1	3	
petroleum	100 %	20	1		3	1			1	1	2
		60	3		4	1				1	2
Phtalic acid	Cold saturated aqueous solution	20		3	1	1	1	1			
		60		4	1	1	1	1			
phenol	90 % aqueous solution	20	4	4	1	1			1	1	4
		60			3	1			1	3	4
phenylhydrazine	100 %	20		4	3	1				4	
		60				1				4	
perchlorethylene	100 %	20	3		4	1			1		3
		60		4					1		3
		80				3			1		4
Phosphoric acid	Aqueous solutions up to 30%	20	3	4	1	1	1	1	1	1	3
		80	4	4	3	1	1	1	1	1	3
	50 % aqueous solution	20	4	4	1	1	1	1		1	3
		60	4	4	3	3	1	1		1	4
	85 % aqueous solution	20	4	4	1	1	1	1	1	1	4
		60		4	3	3	1	1	1	1	4

CHEMICAL COMPATIBILITY CHART

1 : Little or no effect 2 : Minor effect 3 : Moderate effect 4 : Severe effect

CHEMICAL PRODUCT	CONCENTRATION	TEMP °C	PA	PU	PE	PVDF	FEP	PFA	PTFE	PVC	NBR
phosphorous oxychloride	100 %	20			1	1			1		
		60			3	1			1		
		80							1		
phosphorous trichloride	100 %	20			1	1			1	4	
		60			3	3			1	4	
Picric acid	1 % aqueous solution	20	3	4	1	1	1	1	1	1	2
		60	4	4		1	1	1	1	4	2
Potassium benzoate	Cold saturated aqueous solution	20			1	1	1	1	1	1	1
		60			1	1	1	1	1	1	1
Potassium bichromate	Saturated aqueous solution	20		1	1	1	1	1		1	
		60		3	1	1	1	1		1	
Potassium borate	All aqueous solution concentrations	20			1		1	1		1	
		60			1		1	1		1	
Potassium bromate	Cold saturated aqueous solution	20		1	1	1	1	1	1	1	
		60			3	1	1	1	1	1	
Potassium bromide	All aqueous solution concentrations	20	1		1	1	1	1	1	1	
		60			1	1	1	1	1	1	
Potassium carbonate	Cold saturated aqueous solution	20	1		1	1			1	1	
		60	1		1	3			1	1	
Potassium chloride	Cold saturated aqueous solution	20	1	1	1	1			1	1	
		60		3	1	1			1	1	
Potassium chloride	All aqueous solution concentrations	20	1	1	1	1			1	1	
		60	1	3	1	1			1	1	
Potassium chromate	Cold saturated aqueous solution	20		1	1	1			1	1	
		60		3		1			1	1	
Potassium cyanide	Cold saturated aqueous solution	20		4	1	1			1	1	
		60		4	1	3			1	1	
Potassium hydroxide	50 % en solution aqueuse	20	1	4	1	4			1	1	
		60	4		1				1	1	
Potassium iodide	Cold saturated aqueous solution	20	1	1	1	1			1		
		60	1	3	1	3			1		
potassium permanganate	Cold saturated aqueous solution	20		4	1	1			1	1	3
		60		4	3	1			1	1	3
potassium persulfate	All aqueous solutions	20		1	1				1	1	
		60		1	1				1	1	
potassium sulfate	All aqueous solutions	20		1	1	1			1	1	
		60		3	3	1			1	1	
propane	100 % liquid or gaseous	20	1	1	3	1			1		2
		60		3		1			1		2
propanol	100 %	20	1	4	1	1			1		2
		60	3		3	3			1		2
Propionic acid	50 % aqueous solution 100 %	20		4	1	1	1	1	1		
		60		4	1	1	1	1	1		
		20			1	1	1	1			
		60			3	1	1	1			
propylene oxide	100 %	20			1	1					4
		40									4
pyridine	100 %	20	1	4	1	3			1		4
		60				3			1		4
		100				4			1		4
silver nitrate	Cold saturated aqueous solution	20		1	1	1			1	1	
		60		3	4	1			1	1	
Silicone oil	100 %	20	1	1	1				1	1	
		40		1	1					1	
		60	1	3	1					1	

CHEMICAL COMPATIBILITY CHART

1 : Little or no effect

2 : Minor effect

3 : Moderate effect

4 : Severe effect

CHEMICAL PRODUCT	CONCENTRATION	TEMP °C	PA	PU	PE	PVDF	FEP	PFA	PTFE	PVC	NBR
Sodium acetate	All aqueous solutions	20			1	1	1	1	1		4
		60			4	1	1	1	1		4
		80				1	1	1	1		4
Sodium bicarbonate	Cold saturated aqueous solution	20	1	1	1	1	1	1		1	1
		60	1	3	3	1	1	1		1	1
Sodium bisulfite	All aqueous solution concentrations	20		1	1	1	1	1		1	
		60		3	3	1	1	1		1	
Sodium bromide	All aqueous solution concentrations	20	1		1	1	1	1	1	1	
		60			1	1	1	1	1	1	
Sodium carbonate	Cold saturated aqueous solution	20	1		1	1			1	1	
		60	1		3	3			1	1	
Sodium chromate	Aqueous solution	20		1	1	1					
		60		3		1					
Sodium chloride	All aqueous solution concentrations	20	1	1	1	1			1	1	
		60	1	3	3	1			1	1	
Sodium chlorite	Aqueous solution	20		1	1	1			1	1	
		40		3		1			1	1	
		60		3		1			1	1	
Sodium fluoride	Cold saturated aqueous solution	20		4	1	1			1	1	
		60		3					1	1	
Sodium hypochlorite (javel water)	100 %	20	3	4	3	4			1	1	3
		60	4	4	4	4			1	1	4
Sodium hyposulfite	Photographic fixing bath	20		1	1	1					
		60		3	1	1					
Sodium iodide	Cold saturated aqueous solution	20	1	1	1	1					
		60		3		3					
sodium nitrate	Cold saturated aqueous solution	20	3		1	1			1	1	
		60	4						1	1	
sodium nitrate saltpetre	50 % aqueous solution	20	1	1	1	1			1	1	
		60	3	3	3	1			1	1	
sodium peroxide	100 %	20							1		
		60							1		
sodium silicate	All aqueous solutions	20	1		1	1			1	1	
		60	1		3	3			1	1	
sodium sulfate	Cold saturated aqueous solution	20	1	1	1	1			1	1	
		60		3	3	1			1	1	
sodium sulfite	Cold saturated aqueous solution	20	1	1	1	1			1	1	
		60		3	3	1			1	1	
sodium thiosulfate	Cold saturated aqueous solution	20		1	1	1				1	
		60		3	3	A				1	
Stearic acid	100 %	20	1	4	1	1	1	1	1	1	2
		60	4	4	3	1	1	1	1	1	2
Sulfur dioxide	100 % et dry	20	3	4	1	3	1	1	1	1	
		60	4	4	1	4	1	1	1	1	
Sulfur trioxide	100 %	20	4	4	4	4	1	1	1	1	
		60					1	1	1	4	
Sulfuric acid	60 % aqueous solution	20	4	4	1	1	1	1	1	1	3
		60	4	4	3	1	1	1	1	1	4
	80 % aqueous solution	20	4	4	1	1	1	1		1	4
		60	4	4	3	1	1	1		1	4
	90 % aqueous solution	20	4	4	3	1	1	1		1	4
		60	4	4		1	1	1		1	4
96 % aqueous solution	20	4	4		1	1	1		1	4	
	60	4	4		1	1	1		1	4	
Sulfurous acid	Cold saturated aqueous solution	20		4	1	1	1	1		1	3
		60		4	4	1	1	1		1	3

CHEMICAL COMPATIBILITY CHART

1 : Little or no effect 2 : Minor effect 3 : Moderate effect 4 : Severe effect

CHEMICAL PRODUCT	CONCENTRATION	TEMP °C	PA	PU	PE	PVDF	FEP	PFA	PTFE	PVC	NBR
Tartaric acid	All aqueous solution concentrations	20	1	4	1	1	1	1	1	1	1
		60	1	4	3	1	1	1	1	1	1
tetrachloroethane	100 % pure chemistry	20			4	4			1		4
		60				4			1		4
tétrachlorure de carbone	100 % pure chemistry	20	3	4	4	1			1	3	3
		60				3			1	4	3
tetrahydrofurane	100 % pure chemistry	20	1	4	4	4			1	4	4
		60				4			1	4	4
Tin chloride	All aqueous solution concentrations	20		1	1	1			1		
		60		3	3	1			1		
Thionyl chloride	100 %	20	4		4	4				4	
		60								4	
toluene	100 % pure chemistry	20	1	4	3	1			1	4	4
		60		4	4	1			1	4	4
		80		4		3			1	4	4
Trichloroacetic acid	100 %	20			1	3	1	1	1		
		60			4		1	1	1		
	50 % aqueous solution	20			1		1	1	1		
		60			1	3	1	1	1		
trichloroethane	100 %	20			4	1			1	4	
		60				3			1	4	
		80				4			1	4	
trichloroethylene	100 %	20	3	4	4	1			1	4	
		60	4	4		3			1	4	
tricresyl phosphate	100 %	20			1					4	
		60			3					4	
triethanolamine	100 %	20		4	1	1			1	4	
		60		4	1				1	4	
triethylamine	100 %	20		4		3			1	1	
		60		4		4			1	1	
urea	All aqueous solutions up to 30% concentration	20			1	1			1	1	
		60			1	1			1	1	
		100				3			1		
Vegetable oils and lubricants	100 %	20	1	1	1	1			1	1	1
		40	1	1	4	1			1	1	1
		60		3		1			1	1	1
Vinyl acetate	100 %	20					1	1	1	4	
		60					1	1	1		
Water	100 %	20	1	1	1	1			1	1	2
		60	3	4	3	1			1	1	2
xylene	100 %	20	1	4	4	1			1	4	4
		60		4		3			1	4	4
		100		4		4			1	4	4
Zinc chloride	All aqueous solution concentrations	20	1	1	1	1			1	1	
		60	3	3	3	1			1	1	

MANURIL® POLYAMIDE TUBES**FLEXIBLE OR SEMI-RIGID MANURIL® TUBES**

FLEXIBLE OR SEMI-RIGID MANURIL® TUBES

Flexible or semi-rigid MANURIL® tubes are made from RILSAN® virgin polyamide.

This range is comprised of tubes in polyamide 12 (RILSAN® A which appeared on the market in 1970) or in polyamide 11 (RILSAN® B which appeared in 1947) in the semi-rigid version (PA12PHL or PA11PHL) destined for pneumatic logics or for conveying miscellaneous fluids or in the rigid version (PA12HL) adapted to centralised lubrication with higher working pressures.

RILSAN® is a trade name of Arkema.

his document contains abbreviations designating different mixtures of polyamides and that emanate from the DIN 73378 standard :

- P : Plastified polyamide.
- H : Stabilised polyamide for better resistance to temperature.
- L : Stabilised polyamide for better resistance to ultraviolet.
- I : Modified polyamide for better impact resistance.
- Y : Modified polyamide for better resistance to pressure.

MANURIL® tubes are guaranteed to be made from virgin PA12PHL, a polyamide plastified and stabilised in temperature and light.

MANURIL® tubes are :

- Light and impervious.
- Very durable.
- Generators of low pressure losses.
- Resistant to abrasion and depression.
- Provided with good inertia even at low temperatures.

Polyamides 11 and 12 have good resistance to most chemicals at ambient temperature.

A certain swelling may happen with aromatic hydrocarbons and alcohols without deteriorating the material.

On the other hand, it does not resist very well to concentrated acids, phenols and other chlorinated solvents.

MANURIL® tubes are rigorously calibrated.

For certain dimensions, they are in conformity with NFE 49 100, DIN 74324 or DIN 74378 which define not only dimensional tolerances but also working pressures with safety factors, tests (aging, flexibility, impact resistance, etc...) for their correct use.

They are comprised of 100% virgin material, as required by DIN 74324.

In general, MANURIL® tubes are produced in long lengths on wooden reels.

They are then packed in sachets, boxes or on smaller capacity reels in multiples of 25 metre lengths.

TECALEMIT FLEXIBLES® MANURIL® part N°s are mnemonic and are composed as follows :

Material	Part N° begin	Outer diameter (mm)	Inner diameter (mm)	Length	Color	Packaging
Manuril® PA12 PHL	999	xx	xx	000 (reel)	1 black	T = reel
Manuril® PA12 PHL ABR	998	xx	xx	025 (25m)	2 white	S = sachet
Manuril® PA12 HL Rigid	989	xx	xx	050 (50m)	3 yellow	B = Box
Manuril® PA11 PHL	979	xx	xx	100 (100m)	4 blue	
Manuril® PA11 HL FDA Rigid	969	xx	xx		5 red	
					6 green	
					7 natural	

Example for a sachet 25 metres of white 8x10 MANURIL® tube :

999	10	08	025	2	s
-----	----	----	-----	---	---

Soit : 99910080252S

NFE 49100

POLYAMIDE PA 12 PHL RILSAN A

Polyamide 12 (rilsan A) is a synthetic petrochemical product obtained from butadiene.

With excellent characteristics, this material is more often used for the production of pneumatic tubing.

By consequence, it is available in many diameters and often in 7 colours (natural, black, white, blue, green, red, yellow). They are obtained by calibrated extrusion.

Marking of the tubes is as follows : "TECALEMIT FLEXIBLES - PART N° - MANURIL - DIN 73378 - PA12PHL - ID X OD - BATCH N°".

Admissible working temperatures of manuril tubes are from -40°C to +80°C.

Table of working pressure ratios for MANURIL® tubes according to working temperatures.

T (°C)	-40 à +20	30	40	50	60	80
Pressure (%)	100%	72%	64%	52%	47%	35%

The values of working pressure ratios according to working temperatures indicated above represent only the average of the results obtained from burst pressures divided by a safety factor, given that these are variable according to tube diameter and wall thickness.

METRIC SIZES								
Part N°	Outer diameter (mm)	Inner diameter (mm)	Wall thickness (mm)	Applicable standard	PN 20°C (bar)	PLNE 20°C (bar)	Weight (gr/m)	Bend radius (mm)
9990425000x	4	2,5	0,75		31	93	7,88	20
9990427000x	4	2,7	0,65	NFE 49100	26	78	7,05	25
9990402000x	4	2	1	NFE 49100 & DIN 74324	44	133	9,7	20
9990503000x	5	3	1	NFE 49100	33	99	12,9	25
9990604000x	6	4	1	NFE 49100 & DIN 74324	27	80	16,2	30
9990705000x	7	5	1		22	66	19,4	35
9990805000x	8	5	1,5		32	95	31,3	40
9990855000x	8	5,5	1,25	NFE 49100	26	78	27,5	40
9990806000x	8	6	1	NFE 49100 & DIN 74324	19	58	22,6	40
9991006000x	10	6	2		34	103	51,8	60
9991007000x	10	7	1,5	NFE 49100	25	76	41,3	60
9991075000x	10	7,5	1,25		19	57	35,7	55
9991008000x	10	8	1	NFE 49100 & DIN 74324	15	46	29,1	75
9991209000x	12	9	1,5	NFE 49100 & DIN 74324	19	57	51	80
9991210000x	12	10	1	NFE 49100	13	40	35,6	90
9991411000x	14	11	1,5	NFE 49100	15	49	60,9	90
9991412000x	14	12	1	NFE 49100	11	37	42	100
9991512000x	15	12	1,5	NFE 49100	15	45	65,5	100
99915125000x	15	12,5	1,25		13	41	55,7	110
9991612000x	16	12	2	NFE 49100 & DIN 74324	19	58	91	100
9991613000x	16	13	1,5	NFE 49100	13	40	70,5	120
9991814000x	18	14	2	DIN 74324	17	50	104	110
9992015000x	20	15	2,5		19	55	140	120
9992016000x	20	16	2		15	45	117	130
9992218700x	22	18,7	1,65		13	40	130	220
9992219000x	22	19	1,5		10	29	100	250

x : Color coding

1 = black / 2 = white / 3 = yellow / 4 = blue / 5 = red / 6 = green / 7 = natural / 8 = grey / 9 = purple / 10 = brown / 11 = orange / 12 = pink

POLYAMIDE PA 12 PHL RILSAN A

NFE 49100

IMPERIAL SIZES									
Part N°	Outer diameter		Inner diameter		Wall thickness (mm)	PLNE 20°C (bar)	PN 20°C (bar)	Weight (gr/m)	Bend radius (mm)
	mm	Inch	mm	Inch					
999392218000x	3,92	-	2,18	-	0,87	114	36	8,67	20
999476317000x	4,76	3/16"	3,17	1/8"	0,8	84	28	10,6	30
999635476000x	6,35	1/4"	4,76	3/16"	0,8	59	19	14,4	40
999794635000x	7,94	5/16"	6,35	1/4"	0,8	44	14	18,6	50
999952714000x	9,52	3/8"	7,14	9/32"	1,19	44	14	32,5	70
999127952000x	12,7	1/2"	9,52	3/8"	1,59	57	19	57	70

x : Color coding

1 = black / 2 = white / 3 = yellow / 4 = blue / 5 = red / 6 = green / 7 = natural / 8 = grey / 9 = purple / 10 = brown / 11 = orange / 12 = pink

MANUFACTURING TOLERANCES			
Part N°	Tolerance on outer diameter (mm)	Tolerance on inner diameter (mm)	Tolerance on wall thickness (mm)
9990425000x	+0.05 / -0.08	+0.10 / -0.10	
9990427000x	+0.05 / -0.08	+0.10 / -0.10	
9990402000x	+0.05 / -0.08	+0.10 / -0.10	
9990503000x	+0.05 / -0.08	+0.10 / -0.10	
9990604000x	+0.05 / -0.10	+0.10 / -0.10	
9990705000x	+0.05 / -0.10		+0.08 / -0.08
9990805000x	+0.05 / -0.10		+0.08 / -0.08
9990855000x	+0.05 / -0.10		+0.08 / -0.08
9990806000x	+0.05 / -0.10		+0.08 / -0.08
9991006000x	+0.05 / -0.10		+0.08 / -0.08
9991007000x	+0.05 / -0.10		+0.08 / -0.08
9991075000x	+0.05 / -0.10		+0.08 / -0.08
9991008000x	+0.05 / -0.10		+0.08 / -0.08
9991209000x	+0.05 / -0.10		+0.08 / -0.08
9991210000x	+0.05 / -0.10		+0.08 / -0.08
9991411000x	+0.05 / -0.10		+0.08 / -0.08
9991412000x	+0.05 / -0.10		+0.08 / -0.08
9991512000x	+0.05 / -0.10		+0.08 / -0.08
99915125000x	+0.05 / -0.10		+0.08 / -0.08
9991612000x	+0.05 / -0.10		+0.08 / -0.08
9991613000x	+0.05 / -0.10		+0.08 / -0.08
9991814000x	+0.10 / -0.15		+0.08 / -0.08
9992015000x	+0.10 / -0.15		+0.15 / -0.15
9992016000x	+0.10 / -0.15		+0.10 / -0.10
9992218700x	+0.10 / -0.15		+0.10 / -0.10
9992219000x	+0.10 / -0.15		+0.10 / -0.10
999392218000x	+0.05 / -0.08	+0.10 / -0.10	
999476317000x	+0.05 / -0.08	+0.10 / -0.10	
999635476000x	+0.05 / -0.10	+0.10 / -0.10	
999794635000x	+0.05 / -0.10		+0.08 / -0.08
999952714000x	+0.05 / -0.10		+0.08 / -0.08
999127952000x	+0.05 / -0.10		+0.08 / -0.08



DIN 73378
POLYAMIDE PA 12 HL RIGID RILSAN A

ubes made in this material are mainly destined to convey grease or oil under medium pressures.

The elastic modulus of this tube is roughly three times that of plastified polyamide but with very superior resistance to pressure.

Marking of tubes is as follows : "TECALEMIT FLEXIBLES - PART N° - MANURIL - DIN 73378 - PA 12 HL - ID X OD - BATCH N° - FABRICATION FRANÇAISE".

Admissible working temperature of MANURIL® PA 12 HL tubes is between -40°C and +80°C.

Table of MANURIL® PA 12 HL working pressure ratios according to working temperature :

T (°C)	-40 à +20	30	40	50	60	70	80
Pressure (%)	100%	81%	69%	56%	52%	45%	38%

The values of working pressure ratios according to working temperatures indicated above represent only the average of the results obtained from burst pressures divided by a safety factor, given that these are variable according to tube diameter and wall thickness.

METRIC SIZES							
Part N°	Outer diameter (mm)	Inner diameter (mm)	Wall thickness (mm)	PN 20°C (bar)	PLNE 20°C (bar)	Weight (gr/m)	Bend radius (mm)
9890425000x	4	2,5	0,75	62	186	7,88	35
9890525000x	5	2,5	1,25	62	187	15,1	40
9890631000x	6	3,1	1,5	53	168	21,8	45
9890805000x	8	5	1,5	62	186	31,3	70
9890806000x	8	6	1	38	120	22,6	75
9891006000x	10	6	2	67	202	51,8	90

x : Color coding

1 = black / 2 = white / 3 = yellow / 4 = blue / 5 = red / 6 = green / 7 = natural / 8 = grey / 9 = purple / 10 = brown / 11 = orange / 12 = pink

TOLÉRANCES DE FABRICATION			
Part N°	Tolerance on outer diameter (mm)	Tolerance on inner diameter (mm)	Minimum thickness (mm)
9890425000x	+0.05 / -0.08	+0.10 / -0,10	
9890525000x	+0.05 / -0.08	+0.10 / -0,10	
9890631000x	+0.05 / -0.10	+0.10 / -0,10	
9890805000x	+0.05 / -0.10		+0.08 / -0.08
9890806000x	+0.05 / -0.10		+0.08 / -0.08
9891006000x	+0.05 / -0.10		+0.08 / -0.08



POLYAMIDE PA 12 PHL ABR RILSAN A

DIN 74324

Products according to specific requirements of DIN 74324, MANURIL® ABR polyamide tubes are intended for road trailer brake systems.

Their colour is black.

Tube marking is as follows : "TECALEMIT FLEXIBLES - PART N° - MANURIL ABR - DIN 74324 - PA 12 PHL - ID X OD - BATCH N° - FABRICATION FRANÇAISE".

Admissible working temperatures of MANURIL® ABR tubes are between - 40°C and +100°C, with the exception of diameters 10x1, 15x1.5 and 18x2 whose maximum working temperature is +60°C.

In general, MANURIL® ABR tubes are produced in long lengths on wooden reels.

They are then repacked in sachets, boxes or on smaller capacity reels in multiples of 25 metre lengths.

METRIC SIZES

Part N°	Outer diameter (mm)	Inner diameter (mm)	Wall thickness (mm)	PLNE 23°C (bar)	PN 23°C (bar)	Weight (gr/m)	Bend radius (mm)	Maxi T° working (°C)
99804020001	4	2	1,00	135	45	9,70	20	100°
99806040001	6	4	1,00	81	27	16,2	30	100°
99808060001	8	6	1,00	57	19	22,6	40	100°
99809060001	9	6	1,50	81	27	36,4	45	100°
99810080001	10	8	1,00	45	15	29,1	60	60°
99810750001	10	7,5	1,25	57	19	35,4	60	100°
99811080001	11	8	1,50	63	21	46,1	60	100°
99812090001	12	9	1,50	57	19	51,0	60	100°
99814100001	14	10	2,00	66	22	77,7	75	100°
99815120001	15	12	1,50	45	15	65,5	90	60°
99816120001	16	12	2,00	57	19	90,6	95	100°
99818140001	18	14	2,00	51	17	104	100	60°

MANUFACTURING TOLERANCES

Part N°	Tolerance on outer diameter (mm)	Tolerance on inner diameter (mm)	Minimum thickness (mm)
99804020001	+0,10/-0,10	+0,10/-0,10	0,90
99806040001	+0,10/-0,10	+0,10/-0,10	0,90
99808060001	+0,10/-0,10	+0,10/-0,10	0,90
99809060001	+0,15/-0,15	+0,10/-0,10	1,35
99810080001	+0,10/-0,10	+0,10/-0,10	0,90
99810750001	+0,12/-0,12	+0,10/-0,10	1,12
99811080001	+0,15/-0,15	+0,10/-0,10	1,35
99812090001	+0,15/-0,15	+0,10/-0,10	1,35
99814100001	+0,15/-0,15	+0,15/-0,15	1,80
99815120001	+0,15/-0,15	+0,10/-0,10	1,35
99816120001	+0,15/-0,15	+0,15/-0,15	1,80
99818140001	+0,15/-0,15	+0,15/-0,15	1,80

x : Color coding

1 = black / 2 = white / 3 = yellow / 4 = blue / 5 = red / 6 = green / 7 = natural / 8 = grey / 9 = purple / 10 = brown / 11 = orange / 12 = pink



DIN 73378

POLYAMIDE PA 11 PHL RILSAN B

Polyamide PA 11 (Rilsan® B) is of vegetable origin, coming from castor oil.

Apart from its environmental qualities, polyamide 11 has mechanical, physical and thermal properties superior to those of petrochemical derived polyamide 12.

Practically abandoned in the pneumatic tube industry for reasons of cost, it remains an appreciated alternative by some customers for specific tubes.

Marking of these tubes is as follows : "TECALEMIT FLEXIBLES - PART N° - MANURIL - DIN 73378 - PA 11 PHL - ID X OD - BATCH N°- FABRICATION FRANÇAISE".

In general, MANURIL® PA 11 PHL tubes are produced in long lengths on wooden reels.

They are then repacked in sachets, boxes or on reels of smaller capacity in multiples of 25 metres.

The admissible working temperature of MANURIL® PA 11 PHL tubes is between - 40°C and +90°C.

Table of working pressure ratios of MANURIL® PA 11 PHL tubes according to working temperatures.

T (°C)	-40 à +20	30	40	50	60	70	80
Pressure (%)	100%	83%	72%	64%	58%	52%	46%

The values of working pressure ratios according to working temperatures indicated above represent only the average of the results obtained from burst pressures divided by a safety factor, given that these are variable according to tube diameter and wall thickness.

METRIC SIZES											
Part N°	Outer diameter (mm)	Inner diameter (mm)	Wall thickness (mm)	Standard	PLNE 20° C (bar)	PN 20° C (bar)	Weight (gr/m)	Bend radius (mm)	Tolerance on outer diam. (mm)	Tolerance on inner diam. (mm)	Tolerance on wall thickness (mm)
9790427000x	4	2.7	0.65	NFE 49100	80	26	7.16	25	+0.05/-0.08	+0.10/-0.10	
9790604000x	6	4	1	NFE 49100 & DIN 74324	82	27	16.4	30	+0.05/-0.10	+0.10/-0.10	
9790806000x	8	6	1	NFE 49100 & DIN 74324	60	19	22.9	40	+0.05/-0.10		+0.08/-0.08
9791008000x	10	8	1	NFE 49100 & DIN 74324	47	15	29.6	75	+0.05/-0.10		+0.08/-0.08
9791209000x	12	9	1.5	NFE 49100 & DIN 74324	59	19	51.8	80	+0.05/-0.10		+0.08/-0.08
9791210000x	12	10	1	NFE 49100	41	13	36.1	90	+0.05/-0.10		+0.08/-0.08
9791412000x	14	12	1	NFE 49100	38	11	42.6	100	+0.05/-0.10		+0.08/-0.08
9791612000x	16	12	2	NFE 49100 & DIN 74324	60	19	92.4	100	+0.05/-0.10		+0.08/-0.08
9791814000x	18	14	2	DIN 74324	51	17	106	110	+0.10/-0.15		+0.08/-0.08
9792016000x	20	16	2		46	15	119	130	+0.10/-0.15		+0.10/-0.10
9792219000x	22	19	1.5		30	10	102	250	+0.10/-0.15		+0.10/-0.10

Availability of the PA11: on manufacturing

x : Color coding

1 = black / 2 = white / 3 = yellow / 4 = blue / 5 = red / 6 = green / 7 = natural / 8 = grey / 9 = purple / 10 = brown / 11 = orange / 12 = pink

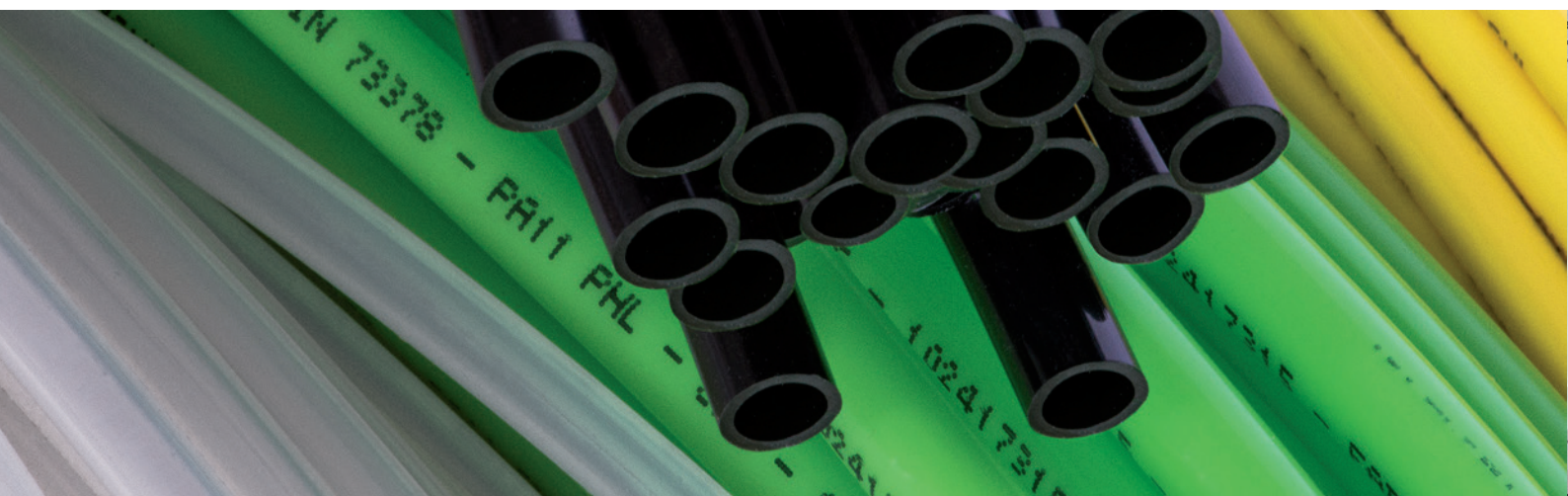

POLYAMIDE PA 11 HL FDA RIGID

DIN 73378

Polyamide PA 11 (Rilsan® B) is of vegetable origin, coming from castor oil.

Apart from its environmental qualities, polyamide 11 has mechanical, physical and thermal properties superior to those of petrochemical derived polyamide 12.

Practically abandoned in the pneumatic tube industry for reasons of cost, it remains an appreciated alternative by some customers for specific tubes.

The admissible working temperature of MANURIL® PA 11 HL FDA tubes is between - 40°C and +90°C.

Marking of these tubes is as follows : “TECALEMIT FLEXIBLES - PART N° - MANURIL - DIN 73378 - PA 11 HL FDA - ID X OD - BATCH N°- FABRICATION FRANÇAISE”.

In general, MANURIL® PA 11 HL FDA tubes are produced in long lengths on wooden reels.

They are then repacked in sachets, boxes or on reels of smaller capacity in multiples of 25 metres.

Table of working pressure ratios of MANURIL® PA 11 HL FDA tubes according to working temperatures.

T (°C)	-40 à +20	30	40	50	60	70	80
Pressure (%)	100%	83%	72%	64%	58%	52%	46%

The values of working pressure ratios according to working temperatures indicated above represent only the average of the results obtained from burst pressures divided by a safety factor, given that these are variable according to tube diameter and wall thickness.

METRIC SIZES							
Part N°	Outer diameter (mm)	Inner diameter (mm)	Wall thickness (mm)	PLNE 20°C (bar)	PN 20°C (bar)	Weight (gr/m)	Bend radius (mm)
9690604000x	6	4	1	160	53	16,1	53
9690806000x	8	6	1	120	38	22,6	75
9691008000x	10	8	1	90	30	29	95
9691210000x	12	10	1	72	24	35	115

MANUFACTURING TOLERANCES			
Part N°	Tolerance on outer diameter (mm)	Tolerance on inner diameter (mm)	Standard colors
9690604000x	+0,05/- 0,08	+0,10/-0,10	On request
9690806000x	+0,05/-0,08	+0,10/-0,10	On request
9691008000x	+0,05/-0,10	+0,10/-0,10	On request
9691210000x	+0,05/-0,10	+0,10/-0,10	On request

x : Color coding

1 = black / 2 = white / 3 = yellow / 4 = blue / 5 = red / 6 = green / 7 = natural / 8 = grey / 9 = purple / 10 = brown / 11 = orange / 12 = pink



NFE 49101

MANULAN® POLYURETHANE

MANULAN® tubes are made of solid polyurethane (thermoplastic polyurethane elastomer or TPU) polyester base. They are obtained by calibrated extrusion. If they are less durable in time than MANURIL® tubes, they have acquired great importance on the market through their flexibility and their higher resistance to impacts and abrasion.

Moreover, the size of logic panels can be reduced by the low bend radius of MANULAN® tubes. MANULAN® tubes are :

- Very resistant to abrasion, wear and impacts.
- Very flexible, even in cold.
- Generators of very low pressure drops.
- Provided with good bend radius.
- Exempt of exudable plastifiers.

MANULAN® standard polyester base tubes are used in pneumatic or hydraulic logic systems and have excellent resistance to oils and hydrocarbons, but do not resist very well to acids and alcalines.

On request, it can be supplied in polyether base polyurethane, the other great family of polyurethanes. Globally, tubes in polyether base polyurethane have the opposite characteristics.

Below you will find a brief table giving the main differences in chemical resistances of polyester and polyether base polyurethanes.

MANULAN® tubes are rigorously calibrated.

For certain dimensions, they are in conformity with NFE 49 101 which defines not only dimensional tolerances but also working pressures according to safety factors with regards to working temperature, along with tests (moisture absorption, aging, flexibility) defining their use.

They are made from 100% virgin material. Marking of tubes is as follows : "TECALEMIT FLEXIBLES - PART N° - MANULAN - ID X OD - BATCH N°".

In general MANULAN® tubes are produced in long lengths on wooden reels. They are then repackaged in sachets, boxes or on smaller capacity reels in multiples of 25 metres length.

Table of working pressure ratios of MANULAN® tubes according to working temperature :

T (°C)	-40° à +20°	30	40	50	60
Pressure (%)	100%	83%	72%	64%	47%

The values of working pressure ratios according to working temperatures indicated above represent only the average of the results obtained from burst pressures divided by a safety factor, given that these are variable according to tube diameter and wall thickness.

METRIC SIZES

Part N°	Outer diameter (mm)	Inner diameter (mm)	Wall thickness (mm)	PLNE 20°C (bar)	PN 20°C (bar)	Weight (gr/m)	Bend radius (mm)
9930318000x	3	1,8	0,6	42	14	6,70	15
9930425000x	4	2,5	0,75	46	15	9,50	20
9930503000x	5	3	1	39	13	15,3	20
9930604000x	6	4	1	30	10	19,2	30
9930855000x	8	5,5	1,25	27	9	32,3	30
9931007000x	10	7	1,5	27	9	48,8	40
9931208000x	12	8	2	30	10	76,7	50
9931495000x	14	9,5	2,25	30	10	102	55

x : Color coding

1 = black / 2 = white / 3 = yellow / 4 = blue / 5 = red / 6 = green / 7 = natural / 8 = grey / 9 = purple / 10 = brown / 11 = orange / 12 = pink

MANULAN® POLYURETHANE

NFE 49101

TABLE OF COMPARISON BETWEEN POLYETHER AND POLYESTER BASE POLYURETHANES

Chemical	Polyester base		Polyether base		
	20°C	60°C	20°C	60°C	
Water	Fresh water	1	2	1	1
	Sea water	1	2	1	1
Anhydride acids diluted	Acetic acid 3%	3	4	1	2
	Lactic acid 3%	3	4	1	2
	Boric acid 3%	1	3	1	2
	Formic acid 3%	2	3	1	2
	Citric acid 3%	2	4	1	2
Mineral acids diluted	Sodium sulphide 3%	2	3	1	2
	Phosphoric acid 3%	2	3	1	2
	Chlorhydric acid 3%	4	4	1	2
	Sulfuric acid 3%	4	4	1	2
	Battery acid	4	4	4	4
	Nitric acid 3%	4	4	4	4
Oxidation solutions	Sodium nitrate 3%	1	2	1	2
	Sodium hypochlorite 3%	3	4	2	3
Reducing solutions	Javel water 3%	2	3	1	2
	Sodium sulphite 3%	1	2	1	2
Alkaline solutions	Calcium hydroxide	1	2	1	2
	Aqueous soda 3%	1	2	1	2
	Caustic soda 3%	2	3	1	2
Alcohols	Triethanolamine 3%	2	2	1	2
	Methanol	3		2	
	Ethanol	2		1	
	Isopropanol	2		1	
Astm test oils	ASTM 1 oil	1		1	
	ASTM 2 oil	1	2	1	2
	ASTM 3 oil	1	2	1	2
Miscellaneous	Anti-freeze	2	3	1	2
	Brake fluid	4	4	4	4
	Ethyl acetate	2		3	

MANUFACTURING TOLERANCES

Part N°	Tolerance on outer diameter (mm)	Tolerance on inner diameter (mm)	Standard colors
9930318000x	+0,10/-0,10	+0,10/-0,05	On request
9930425000x	+0,10/-0,10	+0,10/-0,05	white, blue, natural yellow, black, red, green
9930503000x	+0,10/-0,10	+0,10/-0,05	On request
9930604000x	+0,10/-0,10	+0,10/-0,05	white, blue, natural yellow, black, red
9930855000x	+0,10/-0,10	+0,10/-0,05	white, blue, natural yellow, black, red
9931007000x	+0,15/-0,15	+0,10/-0,07	Blue, natural, black
9931208000x	+0,15/-0,15	+0,10/-0,07	Blue, natural, black
9931495000x	+0,15/-0,15	+0,10/-0,07	On request



MANULENE® LOW DENSITY POLYETHYLENE TUBES

MANULENE® LOW DENSITY POLYETHYLENE

MANULENE® tubes are made from solid polyethylene.

They are obtained by calibrated extrusion.

They are used in low pressure pneumatic logic as well as for conveying certain aggressive fluids.

MANULENE® tubes are :

- Very light (density 0.9), impervious and imputrescible.
- Adapted to negative pressure use.
- Very flexible.
- Very smooth inner bore.
- Translucent.

These tubes have very good chemical resistance with regards to many acids, bases and salt solutions.

Even so, its mechanical qualities may not be sufficient for certain industrial applications and the working temperature of these tubes only covers a reduced range : between -30°C and +60°C as can be seen in the following table.

Marking of tubes is as follows : "TECALEMIT FLEXIBLES - MANULENE - PART N° - ID X OD - BATCH N°".

Table of working pressure ratios of MANULENE® tubes with regards to working temperature :

T (°C)	-30° à 0°	20°	40°	50°	60°
Pressure (%)	165%	100%	66%	46%	40%

The values of working pressure ratios according to working temperatures indicated above represent only the average of the results obtained from burst pressures divided by a safety factor, given that these are variable according to tube diameter and wall thickness.

METRIC SIZES

Part N°	Outer diameter (mm)	Inner diameter (mm)	Wall thickness (mm)	PLNE 20°C (bar)	PN 20°C (bar)	Weight (gr/m)	Bend radius (mm)
0010300000	4	2	1	58	12	9	10
0010310000	6	4	1	36	7	14	15
0010320020	8	6	1	27	6	20	24
0010330010	10	8	1	23	5	25	40
0010340000	12	10	1	20	4	31	54
0010360000	14	10	2	26	5	68	80

MANUFACTURING TOLERANCES

Part N°	Tolerance on outer diameter (mm)	Tolerance on inner diameter (mm)	Standard colors
0010300000	+0,10/-0,10	+0,10/-0,10	Natural
0010310000	+0,10/-0,10	+0,10/-0,10	Natural
0010320020	+0,10/-0,10	+0,10/-0,10	Natural
0010330010	+0,10/-0,10	+0,10/-0,10	Natural
0010340000	+0,10/-0,10	+0,10/-0,10	Natural
0010360000	+0,10/-0,10	+0,10/-0,10	Natural

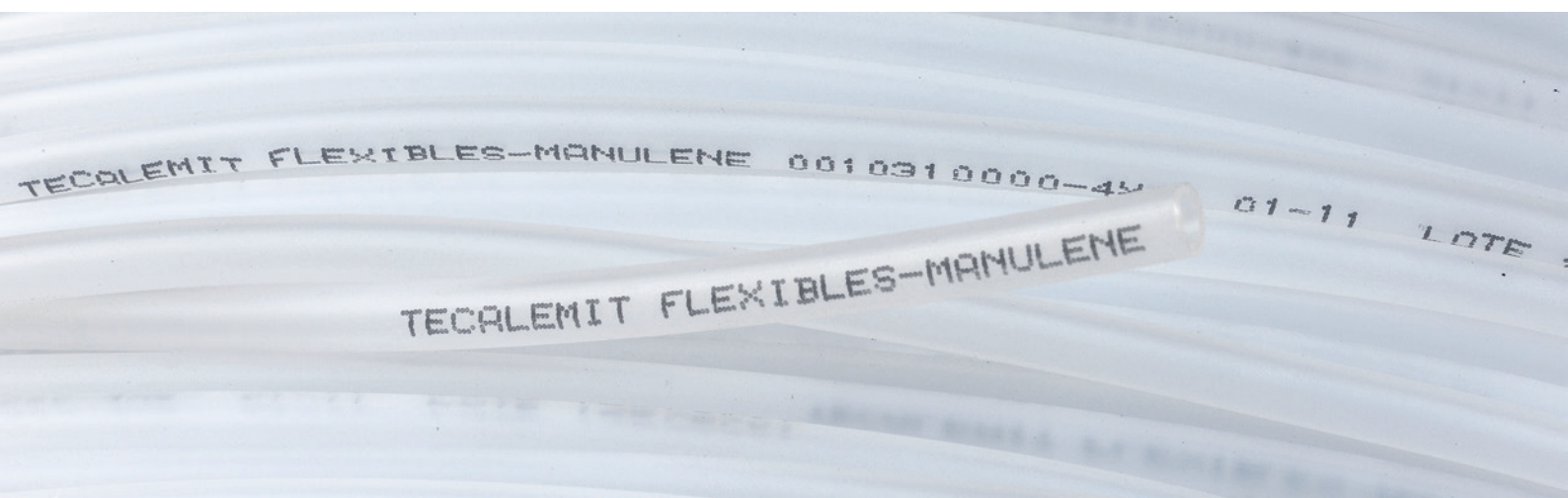

MANULEF® PVDF TUBES

MANULEF® PVDF

MANULEF® tubes are made from virgin kynar 740 polyvinylidene fluorure and are produced by calibrated extrusion. This material appeared on the market in 1955 and is used in translucent grade.

KYNAR® is a trade name of the ARKEMA COMPANY® .

MANULEF® tubes are :

- Very resistant to chemical products.
- Resistant to temperature.
- Provided with very good mechanical properties.
- Insensitive to ultraviolet.
- Very impervious.
- Food quality.
- Nonflammable (UL 10).

MANULEF® tubes are intended for severe conditions of temperature and chemical aggression.

Their admissible working temperature ranges from -20°C to +150°C with very good dimensional stability.

They are also of food quality and have approval by the American FDA (Food & Drug Administration).

They are particularly adapted to outdoor use by their insensitivity to ultraviolet-visible rays and are impurities and insensitive to mould.

MANULEF® are supplied unmarked.

Admissible working temperatures of MANULEF® tubes are between -40°C and +150°C.

Table of working pressure ratios of MANULEF® tubes with regards to working temperature :

T (°C)	-20° à +23°	40°	60°	80°	100°	120°	140°
Pressure (%)	100%	80%	70%	61%	46%	33%	25%

METRIC SIZES

Part N°	Outer diameter (mm)	Inner diameter (mm)	Wall thickness (mm)	PLNE 20°C (bar)	PN 20°C (bar)	Weight (gr/m)	Bend radius (mm)
0010901000	6	4	1	112	56	28	35
0010905000	8	6	1	80	27	39	50
0010910000	10	8	1	62	20	51	70
0010915000	12	10	1	50	17	62	120
0010920000	14	12	1	36	12	90	180

MANUFACTURING TOLERANCES

Part N°	Tolerance on outer diameter (mm)	Tolerance on inner diameter (mm)	Minimum thickness (mm)	Available
0010901000	+0,10/-0,10	+0,10/-0,10	+0,05/-0,05	Incolore/25m
0010905000	+0,10/-0,10	+0,10/-0,10	+0,05/-0,05	Incolore/25m
0010910000	+0,10/-0,10	+0,10/-0,10	+0,05/-0,05	Incolore/25m
0010915000	+0,15/-0,15	+0,10/-0,10	+0,05/-0,05	Incolore/25m
0010920000	+0,15/-0,15	+0,10/-0,10	+0,05/-0,05	Incolore/25m

Other diameters on request

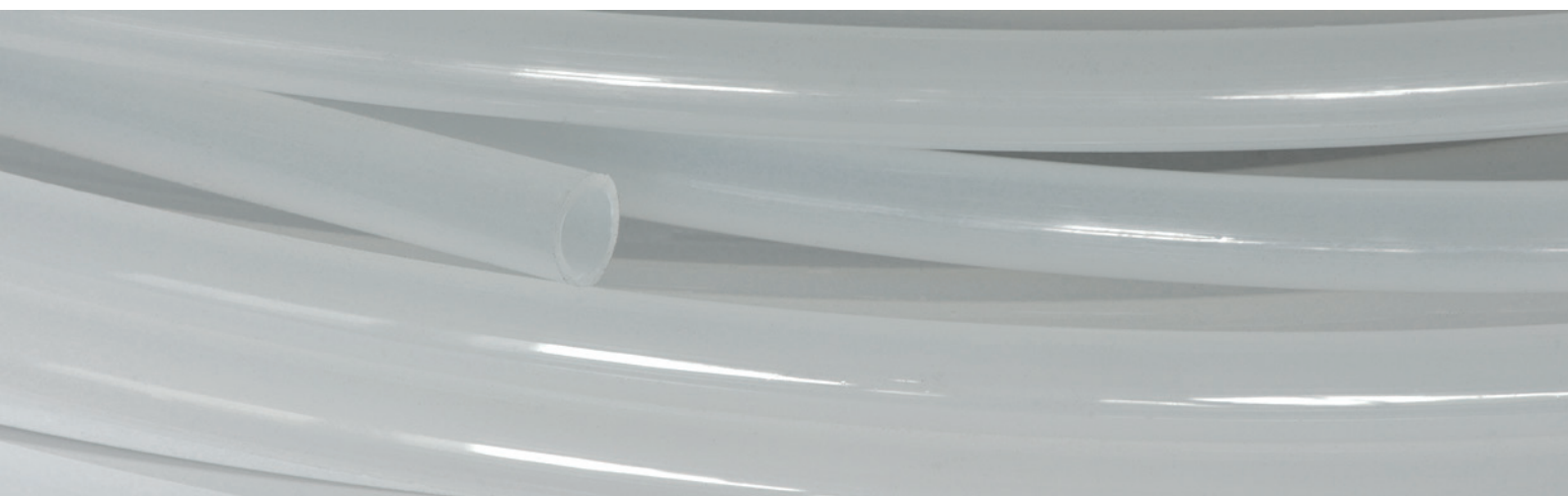

TECAFLON® PTFE

PTFE was discovered at the end of the 1930's, every year its remarkable properties increase the scope of its applications despite the difficulty of its production.

TECAFLON® tubes are made from white sintered polytetrafluorethylene.

They are obtained by lubricated calibrated extrusion in piston machines, which explains the limited lengths of tubes that can be obtained.

TECAFLON® tubes are :

- Inert to chemical products.
- Very resistant to temperature.
- Fragile under mechanical efforts and abrasion.
- Provided with an excellent slipping coefficient.
- Insensitive to ultra violets.
- Nonflammable.

The following table gives a rapid comparison between PTFE and other high performance fluoride plastic materials such as FEP (fluoroethylenepropylene) and PFA (perfluoroalkoxy) whose extrusion is easier.

To resume, FEP has mechanical, chemical and electrical properties practically identical to those of PTFE, even though its resistance to temperature is limited and PFA has dielectric, thermal and chemical properties identical to PTFE.

TECAFLON® tubes are supplied without markings.

Admissible working temperatures of TECAFLON® tubes are comprised between -170°C and +200°C.

TECAFLON® tubes are produced in limited lengths (see table of characteristics) and then packaged in standard lengths of 25 metres.

On request, they can be supplied otherwise.

Table of working pressure ratios of TECAFLON® tubes according to working temperature :

T (°C)	+23°	50°	100°	150°	200°
Pressure (%)	100%	50%	35%	30%	10%

The values of working pressure ratios according to working temperatures indicated above represent only the average of the results obtained from burst pressures divided by a safety factor, given that these are variable according to tube diameter and wall thickness.

COMPARAISON PTFE/FEP/PFA			
CHARACTERISTICS	PTFE	FEP	PFA
Colour	Transparent	Transparent	Transparent
Hardness shore D	58	55	60
Elongation at 23°C	250%	275%	300%
Max working temperature	260°C	200°C	260°C
Min working temperature	-268°C	-73°C	-196°C
Chemical resistance	Excellent	Very good	Very good
Toxicity	None	None	None

PTFE : polytetrafluoroethylene / FEP : fluoroethylenepropylene / PFA : perfluoroalkoxy

TECAFLON® PTFE

METRIC SIZES

Part N°	Outer diameter (mm)	Inner diameter (mm)	Wall thickness (mm)	PLNE 20°C (bar)	PN 20°C (bar)	Weight (gr/m)	Bend radius (mm)
0011210000	4	2	1	60	20	20	16
0011410000	5	3	1	48	16	27	25
0011200000	6	3	1,5	60	20	46	24
0011220000	6	4	1	40	13	34	36
0011280000	8	4	2	60	20	81	32
0011230000	8	6	1	30	10	47	64
0011240000	10	8	1	24	8	61	100
0011250000	12	10	1	20	7	74	145
0011260000	14	12	1,5	17	6	88	200
0011270000	16	14	1	15	5	102	260
0011430000	22	19	1,5	16	5	210	330
0011450000	26	20	3	28	9	470	225
0011460000	28	25	1,5	13	4	271	530

MANUFACTURING TOLERANCES

Part N°	Tolerance on outer diameter (mm)	Tolerance on inner diameter (mm)	maximum out-of-round	Standard colors
0011210000	1	60	0,15	White / 25m
0011410000	1	48	0,15	on request
0011200000	1,5	60	0,17	Sur demande
0011220000	1	40	0,15	White / 25m
0011280000	2	60	0,20	on request
0011230000	1	30	0,15	White / 25m
0011240000	1	24	0,15	White / 25m
0011250000	1	20	0,15	White / 25m
0011260000	1,5	17	0,17	on request
0011270000	1	15	0,15	on request
0011430000	1,5	16	0,17	on request
0011430000	3	28	0,20	on request
0011460000	1,5	13	0,17	on request

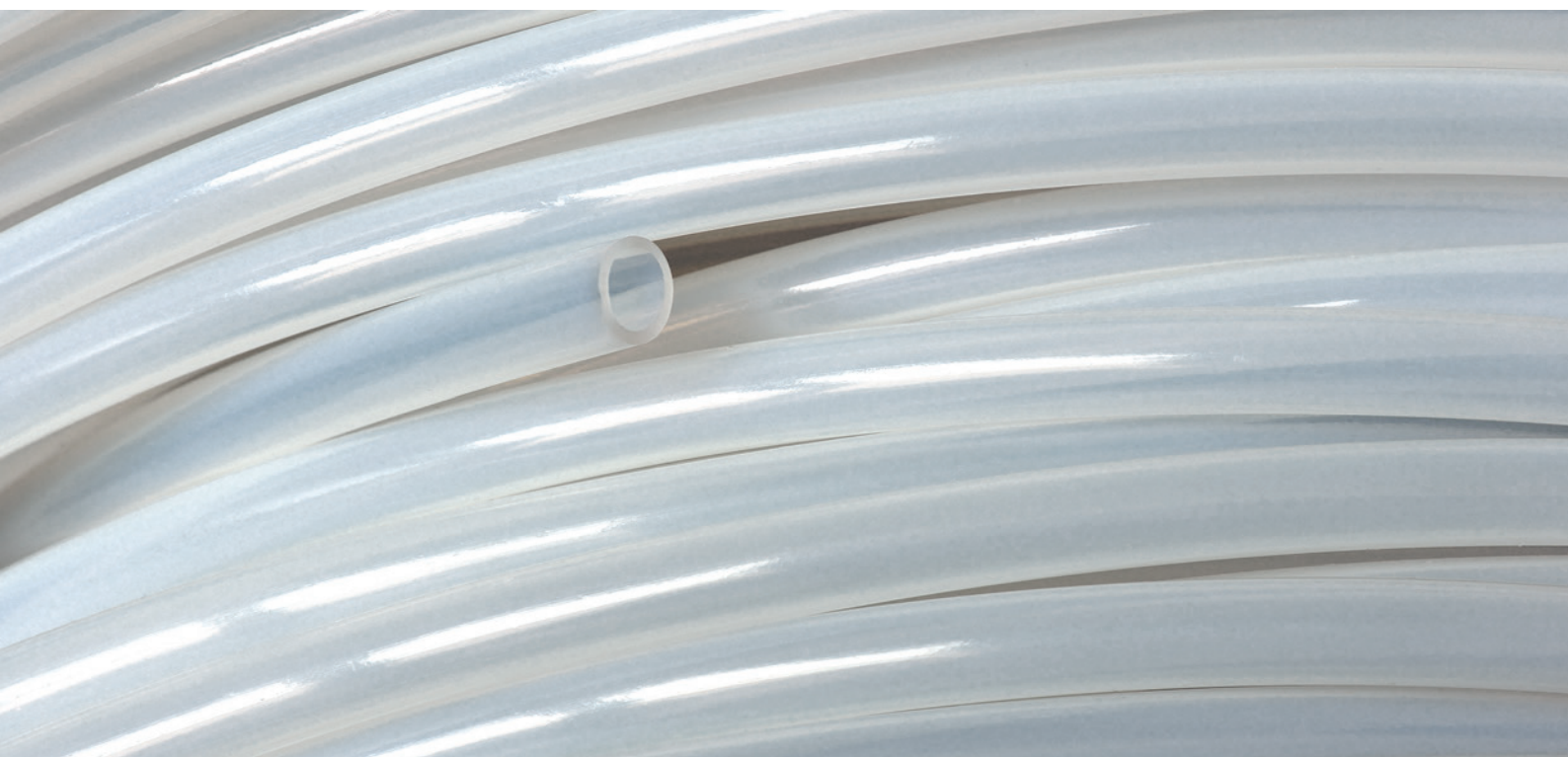

POLYAMIDE COEXTRUDED TAT

The polyamide coextruded TAT is a polyamide monotube covered by a hypalon sheath comprised of a MANURIL® tube which is then covered by a layer of chlorosulfonated polyethylene synthetic rubber (Hypalon, trade name of Dupont de Nemours).

Coextruded TAT is :

- Very resistant to oil and air.
- Very resistant to abrasion and tearing.
- Very resistant to ozone and atmospheric agents.

Coextruded TAT is used for the transfer of fuels in high ambient temperature engine compartments. They can be preformed.

admissible temperature range is from -40°C to +80°C in an atmosphere of 140°C (with peaks to 150°C).

Marking of coextruded TAT is as follows : "TECALEMIT FEXIBLES - PART N° - IDXMDXOD - PA12 HYPALON - BATCH N° (WHITE INK)".

Table of working pressure ratios of coextruded TAT with regards to temperature of fluid :

T(°C)	-40° à +20°	30°	40°	50°	60°	80°
Pressure (%)	100%	72%	64%	52%	47%	35%

The values of working pressure ratios according to working temperatures indicated above represent only the average of the results obtained from burst pressures divided by a safety factor, given that these are variable according to tube diameter and wall thickness.

Part N°	Outer diameter (mm)	Middle diameter (mm)	Inner diameter (mm)	Wall thickness (mm)	PN 20° c (bar)	Weight (gr/mm)	Bend radius (mm)	Tolerance on inner diam. (mm)	Available
9932000	8	6	2	3	15	60	16	+0,10/-0,10	On request
9933405	8	6	3	2,5	15	56	16	+0,10/-0,10	On request
9933407	9	6	4,5	2,25	15	67	40	+0,10/-0,10	On request
9933109	9	6	4	2,5	15	71	30	+0,10/-0,10	On request
9932002	11	7	4	3,5	15	114	30	+0,10/-0,10	On request
9932105	11	8	6	2,5	15	92	30	+0,10/-0,10	On request
9933406	12	8	6	3	15	119	28	+0,10/-0,10	On request
9932004	14	6	3	5,5	15	215	30	+0,10/-0,10	On request
9932342	14	10	8	3	15	146	40	+0,10/-0,10	On request
9932106	16	12	10	3	15	171	NC	+0,10/-0,10	On request
9932107	18	8	6	6	15	336	NC	+0,10/-0,10	On request



MONOTUBES & MULTITUBES

POLYAMIDE MONOTUBE WITH PVC SHEATHING

Monotubes are particularly adapted for installations subjected to external aggressions, such as sparks, for example. The technical characteristics of monotubes are identical to standard MANURIL® tubes. They can be connected by push-in fittings after stripping the sheath at the ends.

Marking of monotubes is as follows : "TECALEMIT FLEXIBLES - PART N° - MONOTUBE - ID - BATCH N°".

Part N°	Outer diameter on sheathing (mm)	Outer diameter (mm)	Inner diameter (mm)	Wall thickness (mm)	PLNE 20°C (bar)	PN 20°C (bar)	Weight (gr/mm)	Bend radius (mm)
9920427001	6	4	2,7	1,65	78	26	28	15
9920604001	8	6	4	2	80	27	46	16
9920806001	10	8	6	2	58	19	62	25
9921008001	12	10	8	2	46	15	77	50
9921210001	14	12	10	2	40	13	92	60

Part N°	Tolerance on outer diameter (mm)	Tolerance on inner diameter (mm)	Available
9920427001	+/-0,10	+/-0,10	Long lengths
9920604001	+/-0,10	+/-0,10	Long lengths
9920806001	+/-0,10	+/-0,10	Long lengths
9921008001	+/-0,10	+/-0,10	Long lengths
9921210001	+/-0,10	+/-0,10	Long lengths



MONOTUBES & MULTITUBES

PVC SHEATHED POLYAMIDE MULTITUBE

TECALEMIT FLEXIBLES® multitubes are comprised of MANURIL® tubes as defined in paragraph 3-1 which are then spiralled together, in some cases covered with a polyethylene film, and sheathed with a 1.5mm to 2mm thick polyvinyl chloride coating.

TECALEMIT FLEXIBLES® multitubes :

- Reduce size of bundles comprised of individual tubes. - Increase productivity in installation.
- Protect tubes from impacts and weather.
- Have low bend radius.

The technique of spiralling gives remarkable flexibility and bend radius to the finished product and maintains tubes at the same length in bends.

The thick PVC coating keeps a round shape and ensures excellent protection, not only mechanical but also against many acids, bases, alcohols and oils. The seven MANURIL® colours are used for easy identification of tubes.

Specific productions are regularly carried out, for example incorporating tubes of different diameters, electric or communication cables, pulling cables, a circular reinforcing steel braid placed before the PVC coating, MANULAN® polyurethane tubes.

Marking of TECALEMIT FLEXIBLES® multitubes is as follows : "TECALEMIT FLEXIBLES - PART N° - MULTITUBE N TUBES IDXOD - BATCH N°"(for multitubes of n tubes).

TECALEMIT FLEXIBLES® multitubes are regularly produced in lengths up to 1000 metres on reels.

They are then repacked in multiple lengths of 25 metres.

Table of working pressure ratios of TECALEMIT FLEXIBLES® PA 12 PHL multitubes with regards to working temperature :

T(°C)	-40° à +20°	30°	40°	50°	60°	80°
Pressure (%)	100%	72%	64%	52%	47%	35%

The values of working pressure ratios according to working temperatures indicated above represent only the average of the results obtained from burst pressures divided by a safety factor, given that these are variable according to tube diameter and wall thickness.

Ø 2.7X4					
Part N°	Sheath thickness (mm)	Outer diam.	Description	Bend radius (mm)	Weight (g/m)
9920427002		12	Round-shape twin tube 2.7X4	15	15
9920427102	2		Flat-shape twin tube 2.7X4	15	15
9920427004	2	13,5	Multitube 4T 2.7X4	20	20
9920427007	2	16	Multitube 7T 2.7X4	25	25
9920427012	2	20,5	Multitube 12T 2.7X4	30	30
9920427019	2,5	25	Multitube 19T 2.7X4	35	35

Ø 4X6					
Part N°	Sheath thickness (mm)	Outer diam.	Description	Bend radius (mm)	Weight (g/m)
9920604002		16	Round-shape twin tube 4X6	20	138
9920604102	2		Flat-shape twin tube 4X6	20	95
9920604004	2	18,5	Multitube 4T 4X6	25	172
9920604007	2,5	23	Multitube 7T 4X6	30	245
9920604012	2,5	30	Multitube 12T 4X6	53	405
9920604019	2,5	35	Multitube 19T 4X6	75	560

Ø 6X8					
Part N°	Sheath thickness (mm)	Outer diam.	Description	Bend radius (mm)	Weight (g/m)
9920806002		19,5	Round-shape twin tube 6X8	30	143
9920806102	2		Flat-shape twin tube 6X8	30	110
9920806004	2,2	24,5	Multitube 4T 6X8	36	210
9920806007	2,5	29	Multitube 7T 6X8	40	330
9920806012	2,5	38	Multitube 12T 6X8	70	510
9920806019	2,5	45	Multitube 19T 6X8	95	700

MONOTUBES & MULTITUBES

PVC SHEATHED POLYAMIDE MULTITUBE

Ø 8X10					
Part N°	Sheath thickness (mm)	Outer diam.	Description	Bend radius (mm)	Weight (g/m)
9921008002		23,5	Round-shape twin tube 8X10	50	224
9921008102	2		Flat-shape twin tube 8X10	50	130
9921008004	1,7	27,5	Multitube 4T 8X10	60	282
9921008007	1,7	33,5	Multitube 7T 8X10	60	415
9921008012	1,7	44,5	Multitube 12T 8X10	100	634
9921008019	2	53,5	Multitube 19T 8X10	130	1000

Ø 10X12					
Part N°	Sheath thickness (mm)	Outer diam.	Description	Bend radius (mm)	Weight (g/m)
9921210002		27,5	Round-shape twin tube 10X12	276	60
9921210102	2		Flat-shape twin tube 10X12	120	60
9921210004	2	32,5	Multitube 10X12 - 4 Tubes	378	74
9921210007	1,7	39,5	Multitube 10X12 - 7 Tubes	500	95
9921210012	1,7	53,5	Multitube 10X12 - 12 Tubes	778	150



THERMOFORMED TUBES ON PLAN

Tecalémit Flexibles® thermoformed tubes are custom-made based on plans provided by our customers and after analysis by our research and development department.

They are usually produced from MANURIL® and MANULAN® tubes from our usual manufacturing but can also be made in FEP (Ethylene-Propylene-Perfluorinated) when the temperature constraints are high.

Tecalémit Flexibles also offers thermoformed tubes made from monotubes or even multitubes.

These parts, in comparison to steel, are very resistant to corrosion, extremely light, durable and economical.

They can have all the desired shapes which may have an advantage over metal tubes.

A thermoformed tube is defined by :

- The type of raw material desired : PA12 PHL, PA11PHL, Polyurethane, FEP..
- The outside diameter and the inside diameter of the tube constituting it.
- Its color and length.
- The 3-dimensional shape of the preformed (.step file or coordinate table)
- The possible equipment of the ends by fittings and bending springs.

The spirals which constitute a specific family of thermoformed tubes correspond to tube windings of widely varying diameter and useful lengths.

In addition to the standard characteristics (tube type, internal and external diameters ...) they are defined by :

- The useful length of the spiral (ie maximum length of use to ensure a good afterglow of the tube after use)
- The number of turns.
- The length of the straight parts at the ends.

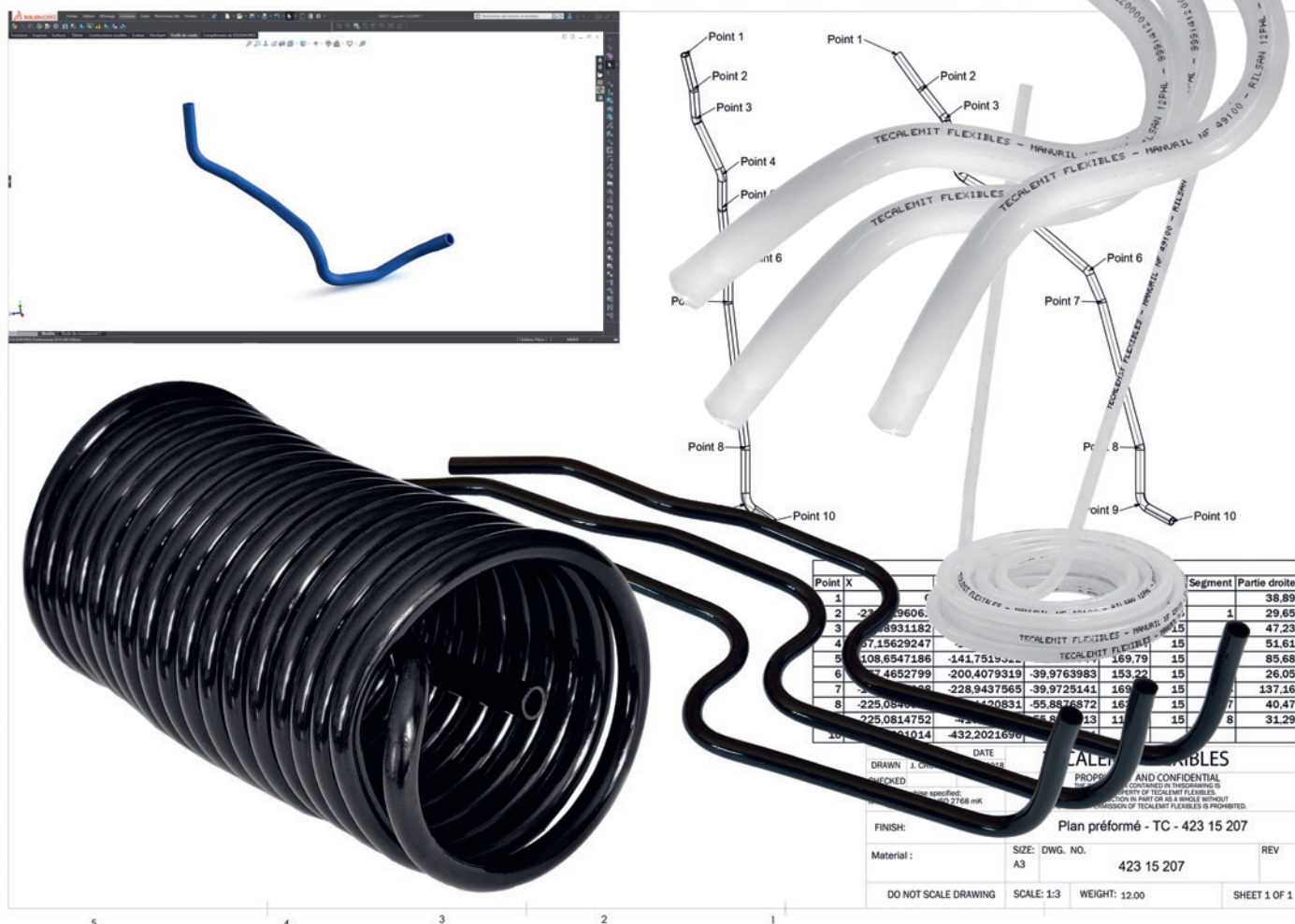

SPIRALLED MANULAN®



POLYURETHANE SPIRALLED TUBES

With better flexibility than polyamide, polyurethane is particularly adapted to the production of spiralled tubes. Moreover, MANULAN® spiralled tubes have an excellent resistance to impact and abrasion. They have straight lengths at each end to facilitate use and connections. Their working pressure is 9 bars at 30°C. they are equipped with 1/4" or 3/8" male BSP fittings according to tube diameter.

Part N°	Outer diameter (mm)	Inner diameter (mm)	Contracted length (mm)	Working length (m)	End length 1 (mm)	End length 2 (mm)	Coil outer diam. (mm)	Weight (g)	Male BSP end-fittings
1089400200399	4	2,5	600	2	100	300	24	80	1/4
1089400400399	4	2,5	760	4	100	300	24	120	1/4
1089900200399	6	4,0	630	2	100	300	32	120	1/4
1089900400399	6	4,0	850	4	100	300	32	200	1/4
1089900600399	6	4,0	1070	6	100	300	32	280	1/4
1089900800399	6	4,0	1290	8	100	300	32	360	1/4
1089100200399	8	5,0	800	2	100	500	42	210	1/4
1089100400399	8	5,0	1000	4	100	500	42	360	1/4
1089100600399	8	5,0	1200	6	100	500	42	510	1/4
1089100800399	8	5,0	1400	8	100	500	42	660	1/4
1089200200399	10	6,5	800	2	100	500	52	300	3/8
1089200400399	10	6,5	1000	4	100	500	52	520	3/8
1089200600399	10	6,5	1200	6	100	500	52	740	3/8
1089200800399	10	6,5	1400	8	100	500	52	960	3/8
1089300200399	12	8,0	790	2	100	500	65	400	3/8
1089300400399	12	8,0	990	4	100	500	65	700	3/8
1089300600399	12	8,0	1190	6	100	500	65	1000	3/8
1089300800399	12	8,0	1380	8	100	500	65	1300	3/8



REINFORCING SLEEVE & TUBE CUTTER FOR PNEUMATICS TUBES

Reinforcing sleeves are also called bushes and allow the use of compression fittings on MANURIL® and MANUlan® tubes.

This type of fitting is recommended in place of quick-connect fittings in the presence of severe working conditions or where safety or applicable standards impose them.

They are systematically used for road vehicle braking systems.

Reinforcing sleeves are usually made in brass.

On request, they can also be supplied in stainless steel or aluminium.

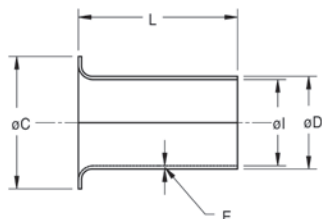

REINFORCING SLEEVES (BUSHES)

Part N°	Outer diameter (mm) D	Tolerance on outer diam. (mm)	Inner diameter (mm) I	Tolerance on inner diam. (mm)	Wall thickness (mm) E	Collar diam. (mm) C	Tolerance on collar diam. (mm)	Length (mm) L	Tolerance on length
43700101	1,5	+/-0,03	1	+/-0,10	0,25	2,5	+/-0,20	8	+/-0,12
43700201	2	+/-0,03	1,4	+/-0,10	0,3	3,2	+/-0,20	8	+/-0,12
43700401	2,5	+/-0,05	1,9	+/-0,10	0,3	4	+/-0,20	8	+/-0,12
43700431	2,7	+/-0,05	2,1	+/-0,10	0,3	4,2	+/-0,20	10	+/-0,12
43701171	3	+/-0,07	2,4	+/-0,10	0,3	4,5	+/-0,20	10	+/-0,12
43702001	4	+/-0,07	3,2	+/-0,10	0,4	6	+/-0,30	10	+/-0,15
43703001	4,5	+/-0,07	3,7	+/-0,10	0,4	6,6	+/-0,30	10	+/-0,15
43704001	5	+/-0,07	4,1	+/-0,10	0,45	6	+/-0,30	12	+/-0,15
43705001	5,5	+/-0,07	4,5	+/-0,10	0,5	8,1	+/-0,30	12	+/-0,15
43703801	6	+/-0,1	5,14	+/-0,10	0,43	8	+/-0,30	15	+/-0,15
43703411	7,5	+/-0,1	6,5	+/-0,10	0,5	10	+/-0,30	15	+/-0,18
43704801	8	+/-0,1	7	+/-0,10	0,5	10	+/-0,30	15	+/-0,18
43707097	8,5	+/-0,1	7,7	+/-0,10	0,4	11	+/-0,30	15	+/-0,18
43705051	9	+/-0,1	7,7	+/-0,10	0,65	12	+/-0,30	15	+/-0,18
43705201	10	+/-0,1	8,7	+/-0,10	0,65	12	+/-0,30	15	+/-0,18
43700141	11	+/-0,02	10	+/-0,10	0,5	14	+/-0,30	15	+/-0,20
43700191	12	+/-0,02	10,7	+/-0,10	0,65	14	+/-0,30	15	+/-0,20
43705221	14	+/-0,02	12,7	+/-0,10	0,65	17,8	+/-0,30	18	+/-0,20
43705241	18	+/-0,02	16,7	+/-0,10	0,65	21,8	+/-0,30	20	+/-0,20



The plastic tube cutter 28908631R is intended for cutting pneumatic tubes up to outer diameter 25 mm.

The blade is not disassembled.



The plastic tube cutter 28908631R is intended for cutting pneumatic tubes up to outer diameter 25 mm.

The blade is not disassembled.

PA/PU TUBE PACKAGING

SACHETS				
Tube diameter	Part n°			
	M90075I	M90204	M90205I	M90207
	500X550 (mm)	585X650 (mm)	340X380 (mm)	700X700 (mm)
4			25m et 100m	
6	100 m		25m et 50m	
7	100m			
8	100m		25m et 50m	150m
10		100m		
12	25m et 50m	100m		
14	25 m	25m, 50m et 100m		25m
15 & 16		25m et 50m		25m
18 & 20		25m		

BOX			
Tube diameter	Part n°		
	M90530	M90529	M90528
	250X250X70 (mm)	380X380X120 (mm)	600X600X100 (mm)
Tube diameter (mm)			
4	25 et 50m	100m	
6	25m	50 et 100m	
7		25m, 50m et 100m	
8		25m, 50m et 100m	
10			25m et 50m
12			25m, 50m et 100m
Type of tube			
PVDF 4X2 25m		x	
PVDF 6X4 25m		x	
PVDF 6X4 50m		x	
PVDF 6X4 100m			x
PVDF 8X6 25m			x
PVDF 8X6 50m			x
PVDF 10X8 25m			x
PVDF 12X10 25m			
PVDF 14X12 25m			
PTFE 4X2 25m			x
PTFE 6X4 25m			x
PTFE 6X4 100m			x
PTFE 8X6 25m			x
PTFE 10X8 25m			x
PTFE 12X10 25m			x
FEP 4X2 25m	x		
FEP 6X4 25m		x	
FEP 8X6 25m		x	
FEP 10X8 25m		x	
FEP 12X10 25m		x	

REELS					
Tube diameter	Max. length of loose reels (m)	Maximum capacity of reels (m)			
		TPFC	TB750	TB1050	TB1200
4	300	2500	5500	13000	
6	300	1100	2400	5900	10650
7	250	800	1800	4300	7820
8	250	600	1300	3300	5990
10	200	400	850	2100	3830
12	150	250	600	1400	2660
14	120	200	400	1000	1950
15	100	160	360	900	1700
16	100	140	320	800	1500
18	70	110	260	600	1180
20	50		200	500	960
21	50		180	450	870
22	50		160	400	790
23	40		140	380	720
24	40		130	350	660
25	30		120	310	610
26	30		115	300	570
27	30		110	275	520
28	30		100	250	490
29	25			240	440
30	25			220	411
31	20			200	385
32	20			190	361
33	20			180	339
34	20			170	320
35	20			160	302
36	20			150	285
37	15			140	270
38	15			130	256
39	15			125	243
40	15			120	231
41				115	220
42				110	209
43				105	200
44				100	191

MANUCLAIR® BRAIDED TRANSLUCENT PVC TUBE

MANUCLAIR® braided PVC tubes are comprised of a flexible translucent PVC inner tube (abbreviation of soft polyvinyl chloride), a single braid of white polyester yarn and a flexible PVC coating.

The inner tube is obtained by extrusion. It is then cooled before passing through a vertical braider and an angle extrusion head which deposits the outer cover. MANUCLAIR® tubes are :

- food quality.
- translucent rendering the conveyed product visible.
- flexible.
- resistant to many common products.

Even though they are less flexible, less sturdy and accept lower working temperatures than their rubber counterparts, MANULEF® tubes are universally used for their main qualities : food compatibility, translucent aspect and resistance to many fluids.

Admissible working temperatures of MANUCLAIR® tubes range from 0°C to +60°C. Marking of tubes is as follows : "TECALEMIT FLEXIBLES - MANUCLAIR - ID X OD - PS/WP 20 BARS 23° - BATCH N° - ALIMENTAIRE"

Table of MANUCLAIR® working pressure ratios with regards to workig temperatures :

T(°C)	0° à 20°	30°	40°	50°	60°
Pressure (%)	165%	72%	50%	38%	25%

The values of working pressure ratios according to working temperatures indicated above represent only the average of the results obtained from burst pressures divided by a safety factor, given that these are variable according to tube diameter and wall thickness.

Part N°	Outer diameter (mm)	Inner diameter (mm)	Wall thickness (mm)	PLNE 23°C (bar)	PS 23°C (bar)	Weight (gr/mm)	Bend radius (mm)	Available
0011005000	11	6,3	2,4	60	15	85	45	25m
0011010000	13	8	2,5	60	15	130	60	25m
0011015000	15	10	2,5	60	15	160	70	25m
0011025000	18	12,5	2,8	60	15	180	90	25m
0011030000	22	16	3	60	15	230	120	25m
0011035000	26	19	3,5	60	15	320	140	25m
0011040000	33	25	4	60	15	450	180	25m

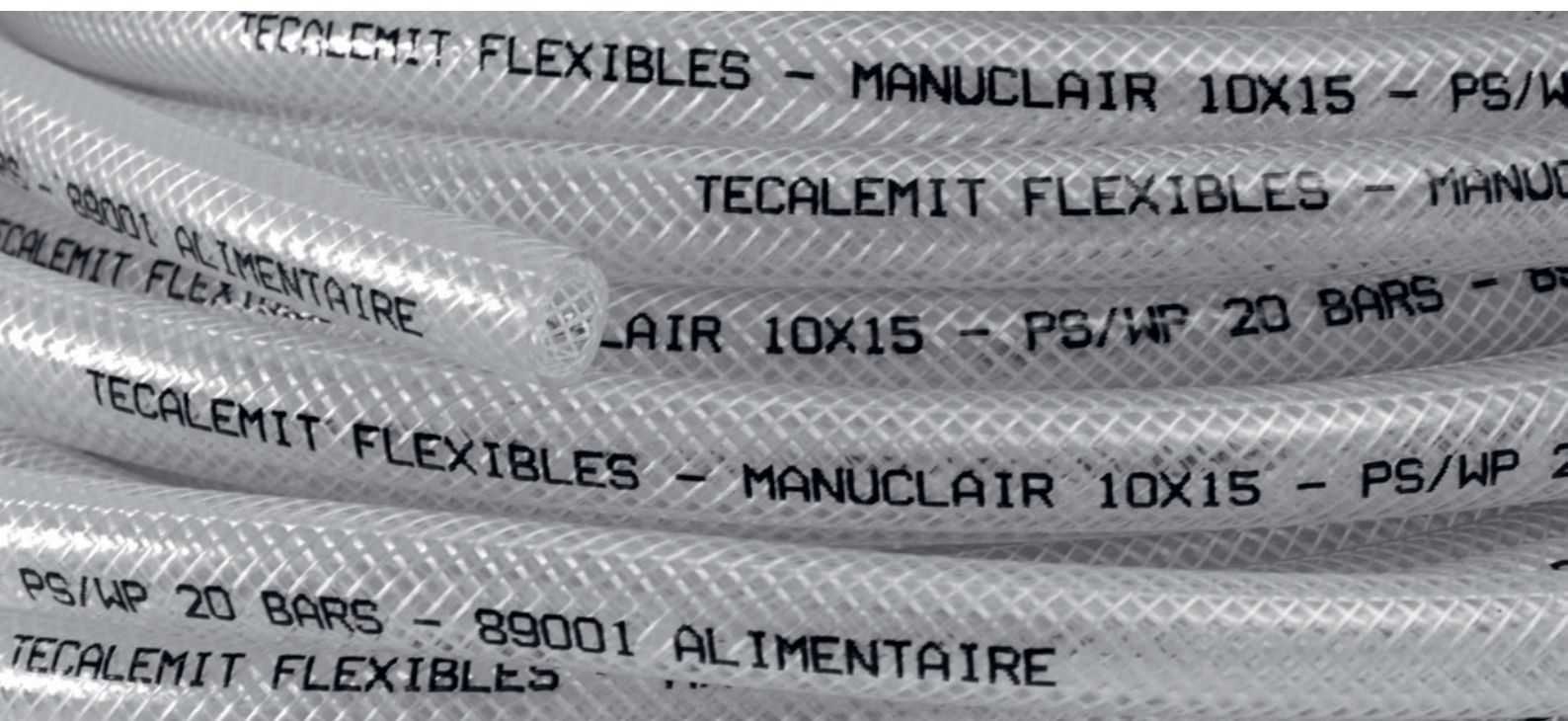

MALUFORM® TUBE

MALUFORM® tubes are comprised of an aluminium sheet covered on both faces by a polyethylene film then covered by a polyethylene coating.

This construction, very light, combines certain advantages of metal tubes and plastic tubes.

The maluform® tube can be cold shaped without any tools and is resistant to corrosion and atmospheric agents.

It can also be buried or sunk in reinforced concrete. it is possible to use push-in fittings on this tube.

Consequently, MALUFORM® tube can be found in pneumatic instrumentation, confined spaces or in humid or corrosive atmospheres.

Working temperatures of maluform® tubes range from -30°C to +70°C with peaks up to 80°C.

In general, maluform® tubes are produced in long lengths on wooden reels.

They are then repacked in 25 metre or 100 metre reels.

MALUFORM® tubes are of black colour.

Marking of tubes is as follows : MALUFORM - Outer Dia. - Part N° - TECALEMIT FLEXIBLES - batch N°

Part N°	Outer diameter (mm)	Tolerances (mm)	PS (bars)	Breaking resistance (DaN)	Bend radius (mm)	Weight (kg/km)
0010710000	6	+/-0,10	17,5	45	25	25
0010720000	8	+/-0,10	17,5	60	30	42
0010730000	10	+/-0,10	17,5	110	50	48
0010740000	12	+/-0,12	15	135	70	59
0010750000	14	+/-0,15	15	135	90	73

Other sizes on request



TUYAU MANUFLEX®

Manuflex® tubes are comprised of an NBR nitrile rubber inner tube, a single galvanised steel braid and an outer cover in translucent flexible PVC.

The inner tube is obtained by extrusion.

It is then braided in a horizontal braider and passes through an angle head extruder which applies the outer cover in translucent polyvinyl chloride to protect the steel braid from external aggression.

Manuflex® tubes are :

- Very robust with regards to impacts.
- Highly polyvalent.
- Very flexible.
- Easy to maintain.

Very flexible, Manuflex® tube is highly safe for everyday use. its burst pressure is very high and its translucent PVC outer cover, whilst protecting the steel braid, allows users to check the condition of same.

It is for this reason that this is used as a multipurpose hose in the chemical industry.

Admissible working temperatures of Manuflex® tubes range from 0°C to +60°C.

Marking of manuflex tubes is as follows : TECALEMIT FLEXIBLES - PART N° - MANUFLEX - ID - BATCH N°

Table of MANUFLEX® working pressure ratios with regards to workig temperatures :

T(°C)	0° à 20°	30°	40°	50°	60°
Pressure (%)	100%	100%	100%	100%	100%

The values of working pressure ratios according to working temperatures indicated above represent only the average of the results obtained from burst pressures divided by a safety factor, given that these are variable according to tube diameter and wall thickness.

Part N°	Outer diameter (mm)	Inner diameter (mm)	Wall thickness (mm)	PLNE à 20°c (bars)	PS à 20° c (bars)	Weight (gr/mm)	Bend radius (mm)	Tolerance on outer diam. (mm)	Tolerance on inner diam. (mm)	Available
0010610030	10,2	4	3	130	43	128	30	+0,30/-0,30	+0,50/-0,50	Long lengths
0010610040	12	6	3	114	38	152	40	+0,30/-0,30	+0,50/-0,50	Long lengths
0010610050	15	8	3	114	38	222	60	+0,30/-0,30	+0,50/-0,50	Long lengths
0010610060	16	10	3	108	36	51	75	+0,40/-0,40	+0,50/-0,50	on reques
0010610070	18	12	3	81	27	62	90	+0,40/-0,40	+0,50/-0,50	on reques
0010610080	22	15	3,5	78	26	90	180	+0,40/-0,40	+0,50/-0,50	on reques



PNEUMATIC CONNECTORS

TOOL-LESS MODULAR RECTANGULAR CONNECTOR

Made in anodised aluminium alloy and plated brass for the inserts, it allows connection of from 1 to 12 tubes (dias. 4, 6 or 8mm) full flow or with auto shut-off using normalised connectors.

This connector offers the advantage of the choice of components without tools.

Selective disconnection under pressure is possible according to choice of female inserts.

It has a polarised assembly and its working pressure is 12 bars.

Inserts are pin-mounted.

Different sections can be mounted on the same circuit and are totally mixable for diameters 4, 6 and 8mm



Fixed base



Housing



Female insert



Male insert



Female auto shut-off insert

Rectangular pneumatic connectors (family PF418) :

Part N°	Description
P452	Fixed base ERX12
P451	Housing and cable gland 29 CRX PG 29
P450	Housing and cable gland 42 CRX PG 42
M9500052	Cover plate for base CPE 12
M9500055	Cover plate for housing CPC 12
P453	Male insert IM Ø4
P454	Male insert IM Ø6
P455	Male insert IM Ø8
P456	Female insert IF Ø4
P457	Female insert IF Ø6
P458	Female insert IF Ø8
P459	Auto shut-off insert IFA Ø4
P460	Auto shut-off insert IFA Ø6
P461	Auto shut-off insert IFA Ø8

Impossibility to mount in housing

Insert	Part N°	Tube Ø 8
Male	IM	1-2-11-12
Female	IF	1-2-11-12
auto shut-off	IFA	1-2-3-4-9-10-11-12

Cable gland clamping range

Part N°	Ø
PG 29	de Ø15 à Ø25
PG 42	de Ø25 à Ø38

Dimensions :

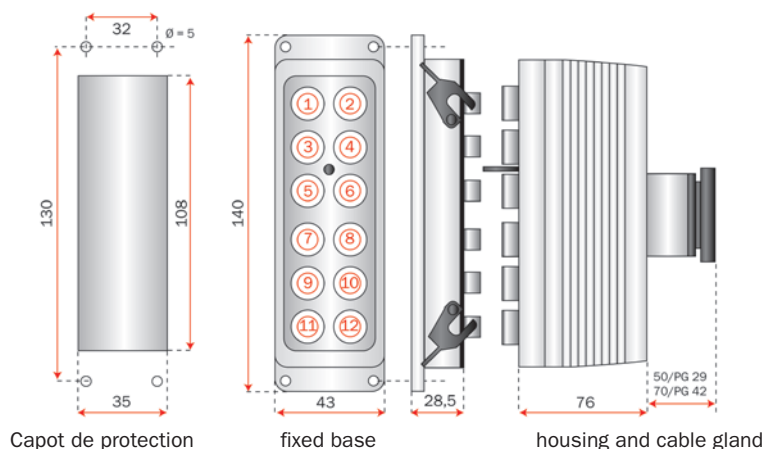

BULKHEAD CONNECTOR

Made in blue anodised aluminium alloy, it ensures simultaneous connection of from 4 to 21 circuits of diameter 4, 6, 8 or 10mm and can be used on multiple bulkheads.

This connector is available in diameters 50 and 80mm and offers the advantage of being able to choose the tool-less components.

The connection is polarised and the long housings ensure mechanical support to the multitubes.

Working pressure is 12 bars and disconnection under pressure is not authorised.



Bulkhead connector



Long housing



Mounting bracket

Choice of bulkhead connector :

N° of tube	Dia. tube	Dia.connector	Dia. multitube	Cable gland size	Cable gland capacity	Panel thickness
7	4	50	15,5	PG 29	25 to 15 mm	1 to 8 mm
12	4	50	20,5	PG 29	25 to 15 mm	1 to 8 mm
21	4	80	23,5	PG 29	25 to 15 mm	1 to 8 mm
7	6	50	21,5	PG 29	25 to 15 mm	1 to 12 mm
12	6	80	28,5	PG 42	38 to 25 mm	1 to 12 mm
4	8	50	23	PG 29	25 to 15 mm	1 to 12 mm
7	8	80	27,5	PG 42	38 to 25 mm	1 to 12 mm
12	8	80	36,5	PG 42	38 to 25 mm	1 to 12 mm
4	10	80	27,5	PG 42	38 to 25 mm	1 to 15 mm
7	10	80	33,5	PG 42	38 to 25 mm	1 to 15 mm

Part N° :

N° of tube	Mounting bracket	Bulkhead connector PC	Long housing CPLT
7	P 205	P 230	P 202
12	P 205	P 231	P 202
21	P 206	P 232	P 203
7	P 205	P 233	P 202
12	P 206	P 234	P 203
4	P 205	P 235	P 202
7	P 206	P 236	P 203
12	P 206	P 237	P 203
4	P 206	P 238	P 203
7	P 206	P 239	P 203

BULKHEAD CONNECTOR

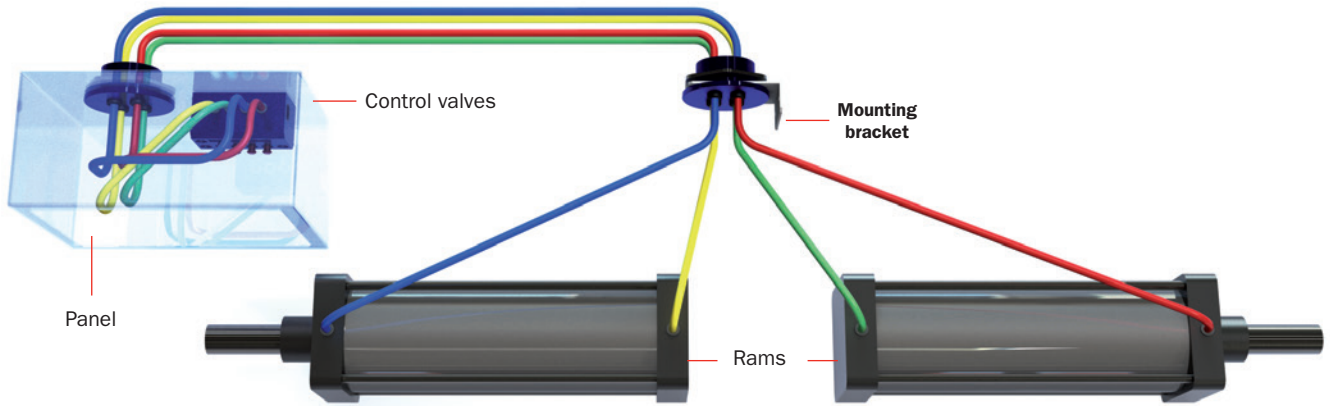

Assembly :

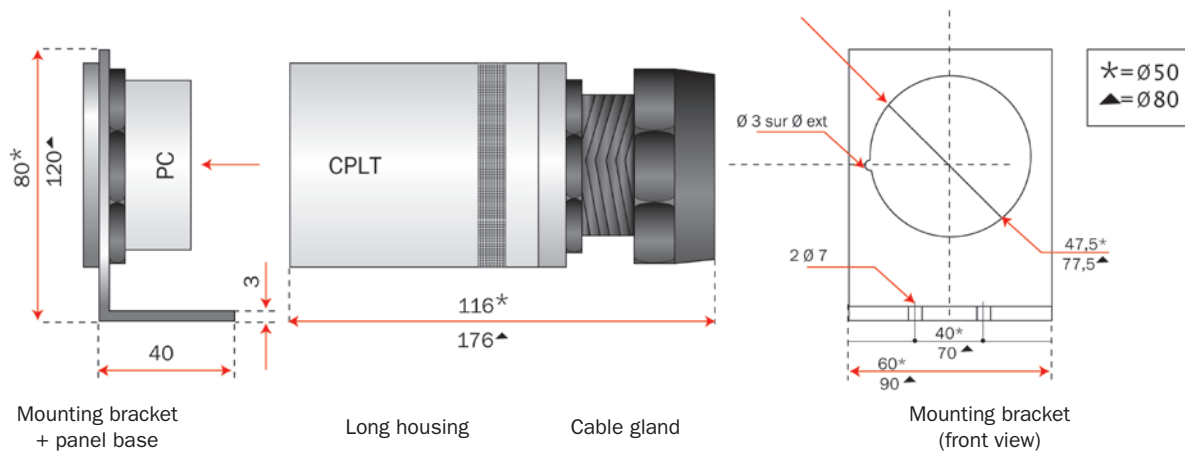

PNEUMATIC CONNECTORS

TOOL-LESS PUSH-IN ROUND CONNECTOR

Made in blue anodised aluminium alloy, it ensures simultaneous connection of from 2 to 21 circuits of diameters 4, 6, 8 or 10mm.

This connector has the added advantage of allowing the choice of the different components without any tools. Connection is polarised and the long housings afford mechanical support to the multitubes.

Working pressure is 12 bars and disconnection under pressure is not authorised.



Mounting bracket



Panel base



Housing base



Short housing



Long housing

Choice of connector :

N° of tube	Dia. tube	Dia. connector	Dia. multitube	Cable gland size	Cable gland capacity	Panel thickness
7	4	50	15,5	PG 29	25 to 15 mm	1 to 4 mm
12	4	50	20,5	PG 29	25 to 15 mm	1 to 4 mm
21	4	80	23,5	PG 29	25 to 15 mm	1 to 6 mm
7	6	50	21,5	PG 29	25 to 15 mm	1 to 4 mm
12	6	80	28,5	PG 42	38 to 25 mm	1 to 4 mm
2	8	50	19,5	PG 29	25 to 15 mm	1 to 6 mm
4	8	50	23	PG 29	25 to 15 mm	1 to 4 mm
7	8	80	27,5	PG 42	38 to 25 mm	1 to 6 mm
12	8	80	36,5	PG 42	38 to 25 mm	1 to 6 mm
2	10	50	23,5	PG 29	25 to 15 mm	1 to 6 mm
4	10	80	27,5	PG 42	38 to 25 mm	1 to 6 mm
7	10	80	33,5	PG 42	38 to 25 mm	1 to 6 mm

Part N° :

N° of tube	Mounting bracket	Panel base EAR	Housing base ECA	Short housing CPC	Long housing CPLT
7	P 205	P 004	P 104	P 200	P 202
12	P 205	P 005	P 105	P 200	P 202
21	P 206	P 018	P 118	P 201	P 203
7	P 205	P 009	P 109	P 200	P 202
12	P 206	P 010	P 110	P 201	P 203
2	P 205	P 011	P 111	P 200	P 202
4	P 205	P 012	P 112	P 200	P 202
7	P 206	P 013	P 113	P 201	P 203
12	P 206	P 014	P 114	P 201	P 203
2	P 205	P 015	P 115	P 200	P 202
4	P 206	P 016	P 116	P 201	P 203
7	P 206	P 017	P 117	P 201	P 203

PNEUMATIC CONNECTORS

TOOL-LESS PUSH-IN ROUND CONNECTOR

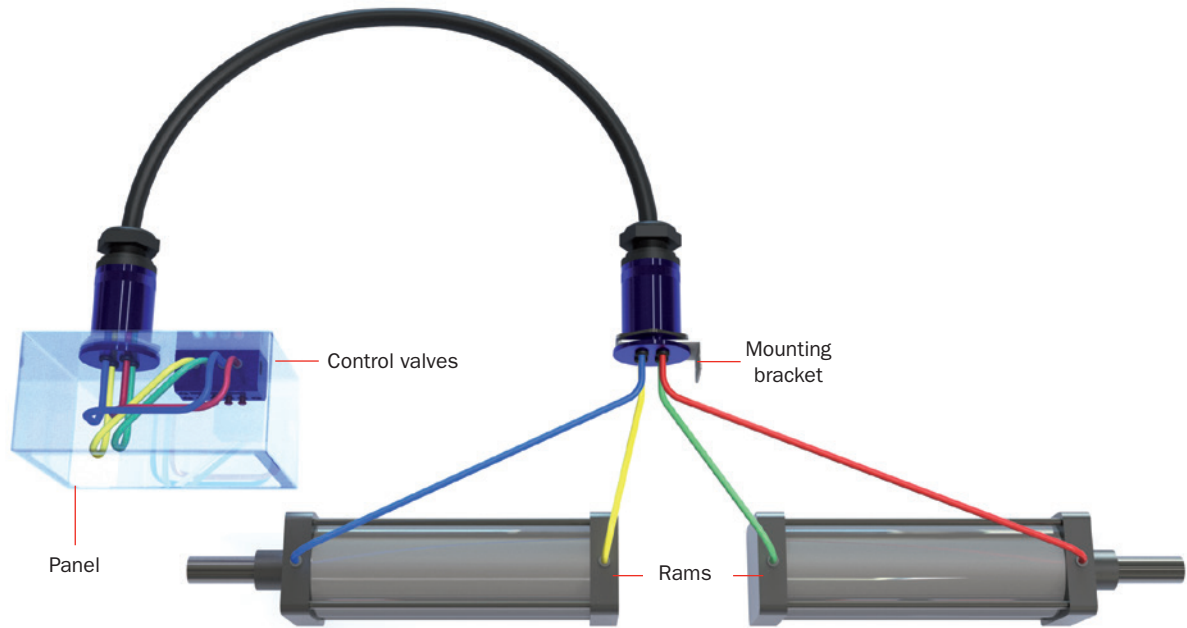

Assembly :

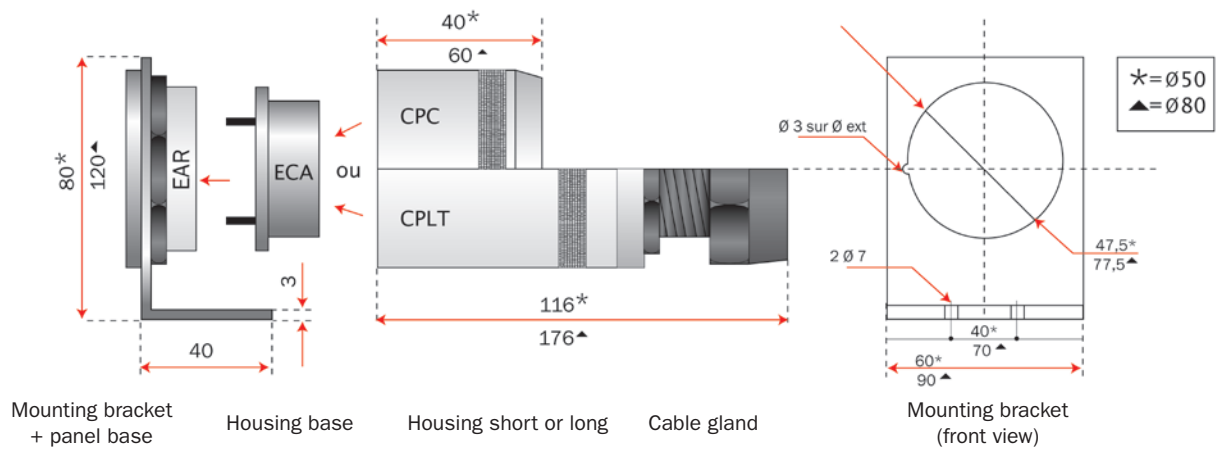

PNEUMATIC CONNECTORS

MODULAR RECTANGULAR ELECTROPNEUMATIC CONNECTOR

Made in anodised aluminium alloy, it ensures the simultaneous connection of 12 pneumatic circuits of diameters 4, 6 or 8mm and electric signals (see table).

Selective disconnection under pressure is authorised according to choice of inserts.

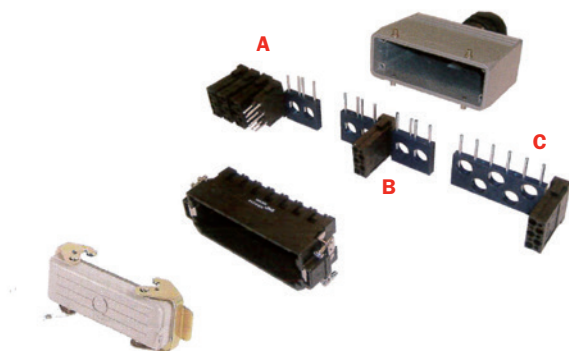

Housing M9500055

Housing CRX12

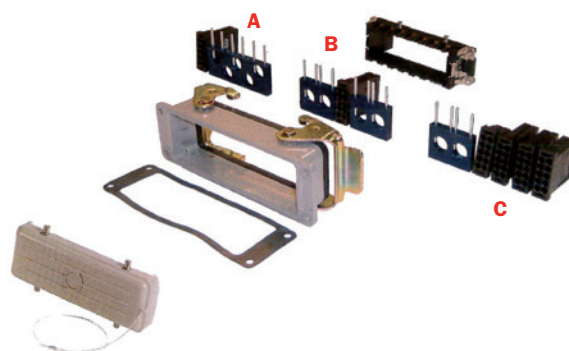

Housing M9500052

Housing CRX12

Connector components :

HOUSING			
Version	Pneumatic part	Electric part	Protection
A	5 ways - Dia. 4, 6, 8 mm Male, female, auto shut-off Part N° CRX12 PG29 / 5PP Part N° CRX12 PG42 / 5PP	1 module 5, 10, 20 contacts male ou female inserts	Housing M9500055
B	4 ways - Dia. 4, 6, 8 mm Male, female, auto shut-off Part N° CRX12 PG29 / 4PP Part N° CRX12 PG42 / 4PP	1 module 5, 10, 20 contacts male ou female inserts	Housing M9500055
C	2 ways - Dia. 4, 6, 8 mm Male, female, auto shut-off Part N° CRX12 PG29 / 2PP Part N° CRX12 PG42 / 2PP	1 to 4 module 5, 10, 20 contacts male ou female inserts	Housing M9500055

BASE			
Version	Pneumatic part	Electric part	Protection
A	5 ways - Dia. 4, 6, 8 mm Male, female, auto shut-off Part n° ERX12 / 5PP	1 module 5, 10, 20 contacts male ou female inserts	Housing M9500052
B	4 ways - Ø4, 6, 8 mm Male, female, auto shut-off Ref ERX12 / 4PP	1 module 5, 10, 20 contacts male ou female inserts	Housing M9500052
C	2 ways - Ø4, 6, 8 mm - Male, female, auto shut-off Ref ERX12 / 2PP	1 to 4 modules 5, 10, 20 contacts male ou female inserts	Housing M9500052

MODULAR RECTANGULAR ELECTROPNEUMATIC CONNECTOR

Choice of different connector components :

PNEUMATIC PART		
Description	Part n°	Code
Pneumatic and electric bases and supports	ERX 12 / 5 PP	P 464
	ERX 12 / 4 PP	P 463
	ERX 12 / 2 PP	P 462
Pneumatic and electric housing PG29 and supports	CRX 12 PG 29 / 5 PP	P 467
	CRX 12 PG 29 / 4 PP	P 466
	CRX 12 PG 29 / 2 PP	P 465
Pneumatic and electric housing PG42 and supports	CRX 12 PG 42 / 5 PP	P 470
	CRX 12 PG 42 / 4 PP	P 469
	CRX 12 PG 42 / 2 PP	P 478

INSERT			
Description	Dia.(mm)	Part n°	Code
Male insert	4	IM 4	P 453
	6	IM 6	P 454
	8	IM 8	P455
Female insert	4	IF 4	P 456
	6	IF 6	P 457
	8	IF 8	P 458
Auto shut-off insert	4	IFA 4	P 459
	6	IFA 6	P 460
	8	IFA 8	P 461

PROTECTION COVER		
Description	Part n°	Code
Base cover	CPE 12	M 950052
Housing cover	CPE 12	M 950055

ELECTRICAL PART							
Modules					Contacts sertis		
Inserts	Part n°	Code	Dia. (mm)	Type	Connection dia (mm2)	Part n°	Code
Contacts 5 male 400V / 50A	M5M	P471	2,5	mâle tourné	0,75 -1	CMT 2,5 -1	P477
					1,5	CMT 2,5 -1,5	P478
					2,5	CMT 2,5 -2,5	P479
Contacts 5 female 400V / 50A	M5F	P472	2,5	femelle tournée	0,75 -1	CFT 2,5 -1	P480
					1,5	CFT 2,5 -1,5	P481
					2,5	CFT 2,5 -2,5	P482
Contacts 10 male 250V / 10A	M10M	P473	1,6	mâle tourné	0,5	CMT 1,6 -0,5	P483
					0,75	CMT 1,6 -1	P484
					1,5	CMT 1,6 -1,5	P485
Contacts 10 female 250V / 10A	M10F	P474	1,6	femelle tournée	0,5	CFT 1,6 -0,5	P486
					0,75	CFT 1,6 -1	P487
					1	CFT 1,6 -1,5	P488
Contacts 20 male 63V / 5A	M20M	P475	1	mâle estampé	0,80 -0,2	CME 1 -0,2	P489
					0,2 -0,52	CME 1 -0,5	P490
Contacts 20 female 63V / 5A	M20F	P476	1	femelle estampée	0,80 -0,2	CFE 1 -0,2	P491
					0,2 -0,52	CFE 1 -0,5	P492

Cable gland clamping range : PG29 = 15 to 25mm, PG 42 = 25 to 38mm

Panel cut-out : 108x35

Mounting : 4 x 5mm bolt holes, centre distance 130x32.



GENERAL TERMS & CONDITIONS OF SALE

Terms of Sales

The information were concerned catalogs, notes and scales are given only as a rough guide and do not commit the seller. The seller is bound by the commitments of his representatives or employees only subject to confirmation emanating from himself. The offers are valid only within the limits of the deadline of option. Unless otherwise stipulated, this deadline is of 1 month. The additional stationery are the object of a new offer of the seller. It is that after express acceptance by the seller of order of the buyer that both parts are bound by the sale contract. Except special convention noticed, the acceptance of the offer by the customer involves its membership in the present general terms of sale. In the hypothesis where the buyer would intend to take advantage of opposite clauses, he will have to send to our company a registered letter with recorded delivery in 15 days following his knowledge of the present general terms of sale. A negotiation can then make a commitment to reach a possible agreement between the parties. Since the deadline of 15 days will be sold without appearance of will on behalf of the buyer, the present general terms of sale will be considered as irrevocably accepted without any reserve.

Terms of delivery

Goods are sold, taken and approved in factories or store of the seller, even if the postage-paid is granted. If the shipping is delayed by the buyer and the seller grants it, goods are stored and handled at expenses and risks of the buyer without responsibility for the seller. These measures modify not at all the obligations for payment of the supply and establish no novation to the sale contract. Goods always travel at the risks and the dangers of the buyer, except his recourse against the carrier. It falls to the buyer, when he is himself an addressee of the sending, or to his representative when the buyer makes manage the sending to a third party, to receipt dated to the carrier only having made sure that stationery were delivered to him for the normal deadlines and good state. In case of damage or of absent person, the addressee has to achieve all the formalities of law (in particular reserves on it). The choice of the carrier by the seller does not modify these obligations of the buyer. Except the case where the buyer wishes to choose the carrier or to define condition of the carrier, the shipping are made according to the seller by every possible means by transport, in the most reduced rate. If the buyer imposes his carrier or conditions of transport particular, the seller is entitled to charge him the supplement of the transport costs which he can be brought to support of this fact.

Packaging

The seller incurs no responsibility of the fact that stationery would not have been packed, in the absence of precise commitment of its part on this point in the sale contract.

Property reserve

Ownership transfer of the goods is suspended from the complete payment of their price, in main thing and accessories, the risks, the loss or the deterioration of these goods as well as the damage which they could cause falling however to the buyer from the stake of these at his disposal. The seller will benefit from the right of resumption, consequence of the transfer postponed from the property and if he is put obstacle to this resumption address Mister President of the Commercial court of Quimper ruling in emergency proceeding, so that he orders it. The buyer will have to watch that the identification of the goods is always possible. Products in stock are presumed to be the ones to pay.

Studies and projects

The studies and documents of all kinds transmitted by the seller always stay its whole property. They must be restored to him on his demand. The seller preserves entirely the intellectual property of these projects which can be neither communicated nor executed without his written authorization.

Delivered quantities

The charged quantities are the ones which were really delivered. They can postpone ordered quantities without this fact can entail a contesting on behalf of the buyer.

Delivery deadlines

The delivery deadlines indicated by the seller get on from the date of the acknowledgement of receipt of order. Except express agreement these deadlines are given only as a rough guide and are not rigorous, their overtaking can entail neither cancellation of the order, nor compensation. Even in the case of formal acceptance by the seller, of deadlines the overtaking of which would entail penalties, the execution of stationery can be suspended or delayed without compensation chargeable to the seller if the terms of payment are not observed by the buyer or if the information to be supplied by this last one did not reach the seller in due course. The war, the strikes, the epidemics, the total or partial interruption of transport, the shortage of raw materials, the hindrances resulting from measures of the authority



GENERAL TERMS & CONDITIONS OF SALE

regarding import of responsibility or internal economic regulations, the incidents or accidents of any causes entailing the unemployment of everything of all or any factories, the fire, the flood, the breaking of machine, the difficulties of transport, the accident of manufacturing, the imperfection of the raw material as a result of the deficiency of a supplier, quite other accident or the not attributable event to the seller and presenting an irresistible and unpredictable character which prevents or reduces the manufacturing, is considered as cases of absolute necessity and unload our company of the obligation to deliver, without compensation neither damage interests and, in a general way, any coincidences or of circumstances outside one's control authorizing by rights the suspension of the current contracts or their late execution without compensation(allowance) nor damage.

Prices

Prices are established on the basis of the economic conditions indicated in the offers. They are revisable according to the variation of the costs of their constituent elements within the framework of the legislation in force. Charged prices are the ones current, in particular if necessary according to price lists or scales, the day of the provision of stationery. The variations of price can be, on no account, a motive for termination of the order. Minimum order and postage-paid: these conditions are defined on our price lists.

Payment

The fact that the product is made available to the client triggers invoicing. Supplies shall be paid to the head-office of the vendor within 30 days, or if a specific agreement has been made, by the date stated on the invoice. For any payment made before the due date, the vendor shall offer a discount, the conditions of which are indicated on the invoice. Any amount due and not paid in time shall be subject to interests as a matter of law, and a final notice shall be issued. Interests shall be applied at the legal rate in force plus 50%. These interests shall be invoiced separately at the end of the month. If the buyer does not pay an invoice by its due date, all other invoices become due immediately, even if they had previously given rise to commercial agreements and all sales not yet fully completed and paid shall be void as a matter of law, if this is the choice of the vendor, after a final notice to pay indicating the vendor intends to invoke this clause has been issued and has not been immediately followed by a response from the buyer. The vendor shall then be entitled to repossess or mandate someone to repossess the supplies if their sale has been cancelled as a matter of law. If the buyer objects to this repossession, the vendor can contact the President of the Trade Court of Quimper, ruling in summary proceedings, so that an order is issued. In application to what is mentioned above, received payments shall be applied in priority to supplies not recovered in kind. For any future order, the vendor shall be entitled to demand full payment is made prior to shipping. Any change in the situation of the buyer, such as the sale or placement in collateral of all or part of the business, death, incapacity, dissolution or change in company status, even after the partial execution of the contract or order, shall lead to the application of the same provisions as those mentioned in case of non-payment of invoices.

Warranty

Unless otherwise stipulated, orders are executed according to the standards it exists and with tolerances of use in current quality and without respect in the special use there for which the buyer intends them. The desk clerk has to verify immediately the quantity, the weight, the dimensions and the quality. Goods are guaranteed against the not visible defects of material and manufacturing and against the latent defects during 12 months as from their starting, and at the latest 18 months after the date of provision. During this warranty period, any complaint will necessarily have to be formulated by registered letter with recorded delivery at the latest within one month after the discovery of the defects or the vices and any action must, to be acceptable, be instituted for the deadline of use of 2 months following the complaint. The seller can have only in the pure and simple replacement, in the price list of the most reduced transport, the defective recognized goods without other allowance, so replaced stationery staying its property. The imperfections resulting from a storage, from an assembly or from a use of goods by the clientele in abnormal conditions are excluded from any guarantees, or not corresponding to the rules of art. The seller accepts no return without having authorized him previously.

Test and reception

Goods are checked in the factories of the seller only on the express demand of the buyer and according to the methods suited during the order. The corresponding expenses, in particular the expenses of vacation and report are chargeable to the buyer

Attribution of jurisdiction

In case of contesting, the French law is only application and the courts of the head office of the company are only competent, whatever are the terms of sale and the method of payment suited even in case of call in guarantee or of plurality of applicants or defendants.



“Innovative and present for many years throughout all industries, proposed by an exclusive network of distributors, Tecalemit Flexibles remains a guarantee of quality and offers a wide range of hydraulic and pneumatic connectors”

Tecalemit flexibles™



Tenir au Temps

tubes
Tecalemit™

RCMH
Tecalemit™

flexibles
Tecalemit™

Parc d'activités de kermaria 29120 Pont l'Abbé - France

Tél : +(33) 02 98 82 48 48

e-mail : info@tecalemi.com

